

User manual

Process monitoring

CEP400T



Table of contents

1	Important information	
1.1	Legal note	6
1.2	Exclusion of liability.....	6
1.3	Validity of the document	7
1.3.1	Content and target group.....	7
1.3.2	Other applicable documents	7
1.4	Gender note.....	7
1.5	Displays in the document.....	8
1.5.1	Display of warnings.....	8
1.5.2	Display of general notes	9
1.5.3	Highlighting of texts and images.....	9
1.6	Contact and source of supply	10
2	Safety	
2.1	Basic safety requirements	11
2.2	Organizational measures.....	11
2.2.1	Safety requirements for the operating company.....	11
2.2.2	Selection and qualifications of personnel	12
2.3	Fundamental hazard potential	13
2.3.1	Electrical hazards	13
3	About this product	
3.1	Warranty	14
3.2	Product Identification	15
3.2.1	Position and content of the type plate.....	15
3.3	Function description.....	16
3.3.1	Process monitoring.....	16
3.3.2	Force monitoring.....	16
3.3.3	Force measurement.....	16
3.3.4	Test of the final position of the closed tool.....	17
3.3.5	Networking via Ethernet (Option).....	18
3.3.6	Log CEP 200 (optional)	18

4	Technical data	
4.1	Mechanical specifications	19
4.2	Dimensions	20
4.2.1	Dimensions of installation housing	20
4.2.2	Hole pattern of installation housing (rear view).....	21
4.2.3	Dimensions of wall/table housing	22
4.3	Power supply	22
4.4	Hardware configuration.....	23
4.5	Connections.....	24
4.5.1	Digital inputs	24
4.5.2	Connections.....	27
4.6	Environmental conditions.....	34
4.7	Electromagnetic compatibility	34
4.8	Sensor Analog Standard Signals.....	35
4.9	Measuring sensor supply voltage	35
4.10	Screw sensor with standard signal output	35
4.11	DMS signals.....	36
4.11.1	Built-in version: pin assignment, analog standard signals	36
4.11.2	Pin assignment DMS force transducer	37
4.11.3	Wall-mounted housing: pin assignment of force transducer	38
4.12	Profibus interface.....	39
4.13	Fieldbus interface	40
4.14	Pulse diagrams	42
4.14.1	Measuring mode	42
4.14.2	Measuring mode	43
4.14.3	Offset adjustment via PLC interface force transducer channel 1 + 2	46
5	Transport and storage	
5.1	Temporary storages.....	47
5.2	Dispatch for repair	47
6	Commissioning	
6.1	Preparing System	48
6.2	Starting system	48

7	Operation	
7.1	Monitoring operation	49
8	Software	
8.1	Function of the Software	50
8.2	Software interface	50
8.3	Control elements	51
8.3.1	Function buttons	51
8.3.2	Checkboxes	51
8.3.3	Input field	51
8.3.4	Dialog keyboard	52
8.3.5	Icons	53
8.4	Main menus	55
8.4.1	Select process / Enter process name	55
8.4.2	Configuration	60
8.4.3	Lot size	72
8.4.4	Supplemnt.....	79
8.4.5	Valuation options	89
8.4.6	Messages	91
9	Troubleshooting	
9.1	Detecting faults	92
9.1.1	Acknowledging Messages	92
9.1.2	Analyzing NOK situations	93
9.1.3	Error messages	94
9.2	Battery buffer	96
10	Maintenance	
10.1	Maintenance and repair	97
10.2	Safety during maintenance	97
10.3	Change flash card.....	98
10.4	Battery change.....	99

Maintenance table

11 Repairs

11.1 Repair work..... 101

12 Disassembly and Disposal

12.1 Safety requirements for disassembly..... 102

12.2 Disassembly 102

12.3 Disposal 102

13 Appendices

13.1 Declaration of conformity 103

13.2 UL certificate 105

Index

1 Important information

1.1 Legal note

All rights reserved.

Operating instructions, manuals, technical descriptions and software published by TOX® PRESSOTECHNIK GmbH & Co. KG ("TOX® PRESSOTECHNIK") are copyright and must not be reproduced, distributed and/or otherwise processed or edited (e.g. by copying, microfilming, translation, transmission in any electronic medium or machine-readable form). Any use - including of extracts - contrary to this condition is prohibited without approval in writing by TOX® PRESSOTECHNIK and may be subject to criminal and civil legal sanctions.

If this manual refers to goods and/or services of third parties, this is for example only or is a recommendation by TOX® PRESSOTECHNIK. TOX® PRESSOTECHNIK does not accept any liability or warranty/guarantee with reference to the selection, specifications and/or usability of these goods and services. The use and/or representation of trademarked brands that do not belong to TOX® PRESSOTECHNIK are for information only; all rights remain the property of the owner of the trademarked brand.

Operating instructions, manuals, technical descriptions and software are originally compiled in German.

1.2 Exclusion of liability

TOX® PRESSOTECHNIK has checked the contents of this publication to ensure that it conforms to the technical properties and specifications of the products or plant and the description of the software. However, discrepancies may still be present, so we cannot guarantee complete accuracy. The supplier documentation included with the system documentation is an exception.

However, the information in this publication is checked regularly and any required corrections are included in subsequent editions. We are grateful for any corrections and suggestions for improvement. TOX® PRESSOTECHNIK reserves the right to revise the technical specifications of the products or plant and/or the software or documentation without prior notice.

1.3 Validity of the document

1.3.1 Content and target group

This manual contains information and instructions for the safe operation and safe maintenance or servicing of the product.

- All information in this manual is up to date at the time of print. TOX® PRES-SOTECHNIK reserves the right to make technical changes that improve the system or increase the standard of safety.
- The information is intended for the operating company as well as operating and service personnel.

1.3.2 Other applicable documents

In addition to the available manual, further documents can be supplied. These documents must also be complied with. Other applicable documents can be, for example:

- additional operating manuals (e.g. of components or of a whole system)
- Supplier documentation
- Instructions, such as software manual, etc.
- Technical data sheets
- Safety data sheets
- Data sheets
- Schematics

1.4 Gender note

In order to enhance readability, references to persons that also relate to all sexes are normally only stated in the usual form in German or in the corresponding translated language in this manual, thus e.g. "operator" (singular) for male or female, or "operators" (plural) for male or female". This should in no way convey any gender discrimination or any violation of the principle of equality, however.

1.5 Displays in the document

1.5.1 Display of warnings

Warning signs indicate potential dangers and describe protective measures. Warning signs precede the instructions for which they are applicable.

Warning signs concerning personal injuries

DANGER

Identifies an immediate danger!

Death or severe injuries will occur if appropriate safety measures are not taken.

→ Measures for remedial action and protection.

WARNING

Identifies a potentially dangerous situation!

Death or serious injury may occur if appropriate safety measures are not taken.

→ Measures for remedial action and protection.

CAUTION

Identifies a potentially dangerous situation!

Injury may occur if appropriate safety measures are not taken.

→ Measures for remedial action and protection.

Warning signs indicating potential damage

NOTE

Identifies a potentially dangerous situation!

Property damage may occur if appropriate safety measures are not taken.

→ Measures for remedial action and protection.

1.5.2 Display of general notes

General notes show information on the product or the described action steps.



Identifies important information and tips for users.

1.5.3 Highlighting of texts and images

The highlighting of texts facilitates orientation in the document.

✓ Identifies prerequisites that must be followed.

1. Action step 1

2. Action step 2: identifies an action step in an operating sequence that must be followed to ensure trouble-free operation.

▷ Identifies the result of an action.

▶ Identifies the result of a complete action.

➔ Identifies a single action step or several action steps that are not in an operating sequence.

The highlighting of operating elements and software objects in texts facilitates distinction and orientation.

- <In square brackets> identifies operating elements, such as buttons, levers and (valves) stopcocks.
- "with quotation marks" identifies software display panels, such as windows, messages, display panels and values.
- **In bold** identifies software buttons, such as buttons, sliders, checkboxes and menus.
- **In bold** identifies input fields for entering text and/or numerical values.

1.6 Contact and source of supply

Only use original spare parts or spare parts approved by TOX® PRESSOTECHNIK.

TOX® PRESSOTECHNIK GmbH & Co. KG

Riedstraße 4

88250 Weingarten / Germany

Tel. +49 (0) 751/5007-767

E-Mail: info@tox-de.com

For additional information and forms see

www.tox.com

2 Safety

2.1 Basic safety requirements

The product is state of the art. However, operation of the product may involve danger to life and limb for the user or third parties or damage to the plant and other property.

For this reason the following basic safety requirements will apply:

- Read the operating manual and observe all safety requirements and warnings.
- Operate the product only as specified and only if it is in perfect technical condition.
- Remedy any faults in the product or the plant immediately.

2.2 Organizational measures

2.2.1 Safety requirements for the operating company

The operating company is responsible for compliance with the following safety requirements:

- The operating manual must always be kept available at the operation site of the product. Ensure that the information is always complete and in legible form.
- In addition to the operating manual, the generally valid legal and other binding rules and regulations must be provided for the following content and all personnel must be trained accordingly:
 - Work safety
 - Accident prevention
 - Working with hazardous substances
 - First aid
 - Environmental protection
 - Traffic safety
 - Hygiene
- The requirements and contents of the operating manual must be supplemented by existing national regulations (e.g. for prevention of accidents and for environmental protection).
- Instructions for special operating features (e.g. work organization, work processes, appointed personnel) and supervisory and reporting obligations must be added to the operating manual.

- Take action to ensure safe operation and make sure that the product is maintained in a functional condition.
- Only allow authorized persons access to the product.
- Ensure that all personnel work with awareness of safety and potential dangers with reference to the information in the operating manual.
- Provide personal protective equipment.
- Maintain all safety and information on dangers regarding the product complete and in legible condition and replace as required.
- Do not make any changes, carry out attachments or conversions to the product without the written approval of TOX® PRESSOTECHNIK. Action contrary to the above will not be covered by the warranty or the operating approval.
- Make sure that the annual safety inspections are carried out and documented by an expert.

2.2.2 Selection and qualifications of personnel

The following safety requirements are applicable for the selection and qualifications of personnel:

- Only appoint persons to work on the plant who have read and understood the operating manual, and in particular, the safety instructions before starting work. This is particularly important for persons who only work on the plant occasionally, e.g. for maintenance work.
- Only allow persons appointed and authorized for this work access to the plant.
- Only appoint reliable and trained or instructed personnel.
- Only appoint persons to work in the danger zone of the plant who can perceive and understand visual and acoustic indications of danger (e.g. visual and acoustic signals).
- Ensure that assembly and installation work and the initial commissioning are performed exclusively by qualified personnel who have been trained and authorized by TOX® PRESSOTECHNIK.
- Maintenance and repairs must be performed by qualified and trained personnel only.
- Ensure that personnel who are being trained, instructed or are in an apprenticeship can only work on the plant under the supervision of an experienced person.
- Have work on electrical equipment performed only by electricians or trained persons under the direction and supervision of an electrician in accordance with the electrotechnical regulations.

2.3 Fundamental hazard potential

Fundamental hazard potentials exist. The specified examples draw attention to known hazardous situations, but are not complete and do not in any way provide safety and risk awareness action in all situations.

2.3.1 Electrical hazards

Attention should be paid to electrical hazards particularly inside the components in the area of all assemblies of the control system and motors of the installation.

The following basically applies:

- Have work on electrical equipment performed only by electricians or trained persons under the direction and supervision of an electrician in accordance with the electrotechnical regulations.
- Always keep the control box and/or terminal box closed.
- Before commencing work on electrical equipment, switch off the main switch of the system and secure it against being switched back on inadvertently.
- Pay attention to the dissipation of residual energy from the control system of the servomotors.
- Make sure that the components are disconnected from the power supply when carrying out the work.

3 About this product

3.1 Warranty

Warranty and liability are based on the contractually specified conditions.

Unless specified otherwise:

The TOX® PRESSOTECHNIK GmbH & Co. KG excludes any warranty or liability claims in the event of defects or damage if these are attributable to one or more of the following causes:

- Non-compliance with safety instructions, recommendations, instructions and/or other specifications in the operating manual.
- Non-compliance with the maintenance rules.
- Unauthorized and improper commissioning and operation of the machine or components.
- Improper use of the machine or components.
- Unauthorized constructional modifications to the machine or components or modifications to the software.
- Use of non-genuine spare parts. Batteries, fuses and lamps are not covered by the warranty.

3.2 Product Identification

3.2.1 Position and content of the type plate

The type plate can be found on the back of the device.

Designation on the type plate	Meaning
Type	Product designation
ID No	Material number
SN	Serial number

Tab. 1 Type plate

Type code structure

Setup and function of process monitoring CEP 400T-02/-04/-08/-12 are similar to a large extent. The number of measurement channels differentiates the devices:

Type key	Description
CEP 400T-02:	Two separate measurement channels 'K1' and 'K2'.
CEP 400T-04:	Four separate measurement channels 'K1' to 'K4'.
CEP 400T-08:	Eight separate measurement channels 'K1' to 'K8'.
CEP 400T-12:	Twelve separate measurement channels 'K1' to 'K12'.

3.3 Function description

3.3.1 Process monitoring

The process monitoring system compares the maximum force during a clinching process with the target values that are set in the device. Depending on the result of the measurement, a good/bad message is issued both on the internal display as well as the external interfaces provided.

3.3.2 Force monitoring

Measurement of force:

- For tongs, the force is generally recorded via a screw sensor.
- For presses, the force is recorded via a force sensor behind the die or the punch (monitoring of the maximum value)

3.3.3 Force measurement

The process monitoring system compares the maximum measured force with the set maximum and minimum limit values.

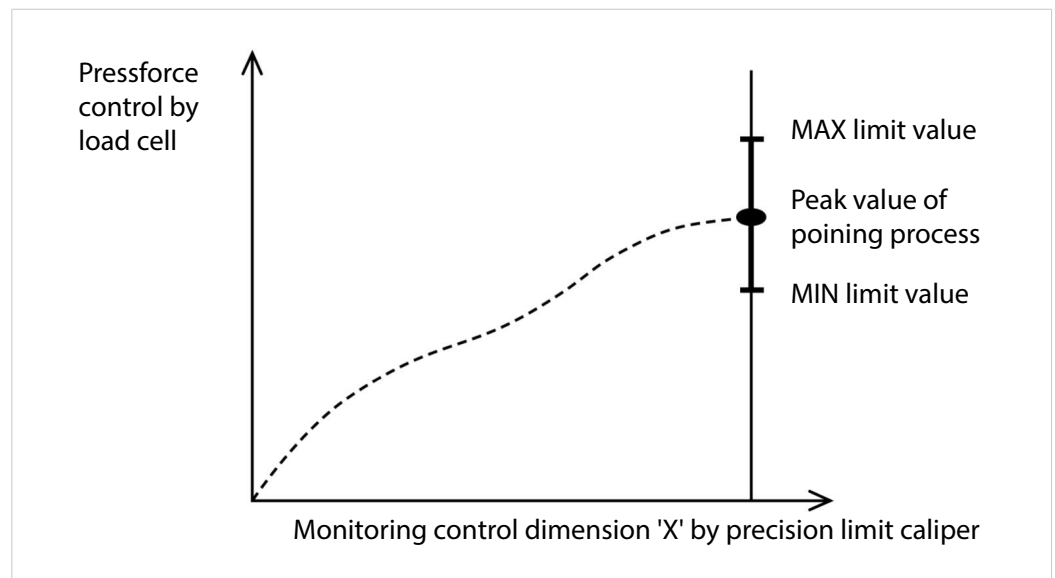

Fig. 1 Force measurement

Changes in a process, e.g. clinching process, results in deviations in the press force. If the measured force exceeds or drops below the fixed limit values, the process is stopped by the monitoring system. To ensure that the process stops at "natural" deviations of the press force, the limit values must be chosen correctly and not too narrow.

The function of monitoring equipment depends mainly on the setting of the evaluation parameter.

3.3.4 Test of the final position of the closed tool

Clinching

The process monitoring system measures and evaluates the maximum force reached.

To make a statement about a clinching process from the set minimum and maximum limits, it must be ensured that the clinching tools were fully closed (e.g. with a precision limit button).

If the measured force is then within the force window, it can be assumed that the 'X' control dimension is in the required range.

The value for control dimension 'X' (residual bottom thickness) is specified in the rest report and can be measured on the piece part with a measuring sensor.

The limits of force must be adjusted to the minimum and maximum values of the control dimension 'X' specified in the test report.

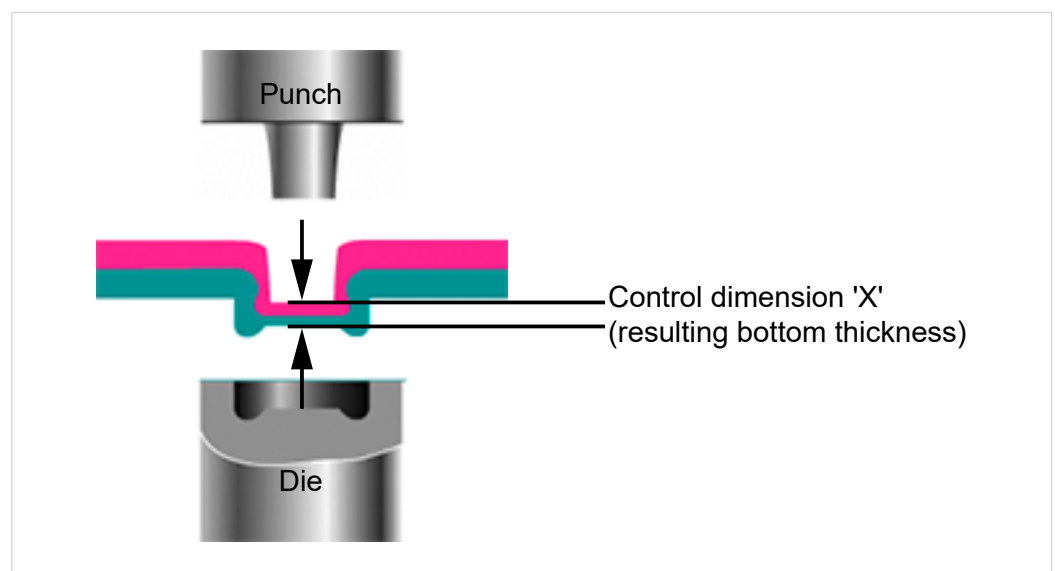

3.3.5 Networking via Ethernet (Option)

Transfer of measuring data to the PC – Ethernet

The PC used for data acquisition can communicate with several CEP 400T devices via the Ethernet interface. The IP address of the individual devices can be configured (see [Change the IP address, Page 83](#)). The central PC cyclically monitors the status of all CEP 400 devices. On termination of a measurement, the result will be read and logged by the PC.

TOX® Software Module CEP 400

The TOX® Software can image the following functions:

- Display and filing of measuring values
- Processing and filing of device configurations
- Offline creation of device configurations

3.3.6 Log CEP 200 (optional)

The CEP 200 model can be replaced with a CEP 400T.

To replace model CEP 200 with a CEP 400T, the CEP 200 interface must be activated. In this case the digital inputs and outputs according to the CEP 200 are occupied. For further information regarding handling, see the CEP 200 manual.

4 Technical data

4.1 Mechanical specifications

Description	Value
Steel panel installation housing	Zinc-coated
Dimensions (W x H x D)	168 x 146 x 46 mm
Installation aperture (W x H)	173 x 148 mm
Display front panel (W x H)	210 x 185 mm
Plastic front panel	EM-immune, conductive
Attachment method	8 x threaded bolts M4 x 10
Protection class according to DIN 40050 / 7.80	IP 54 (front panel) IP 20 (housing)
Films	Polyester, resistance according to DIN 42115 Alcohols, diluted acids and alkalis, household cleaners
Weight	1.5 kg

4.2 Dimensions

4.2.1 Dimensions of installation housing

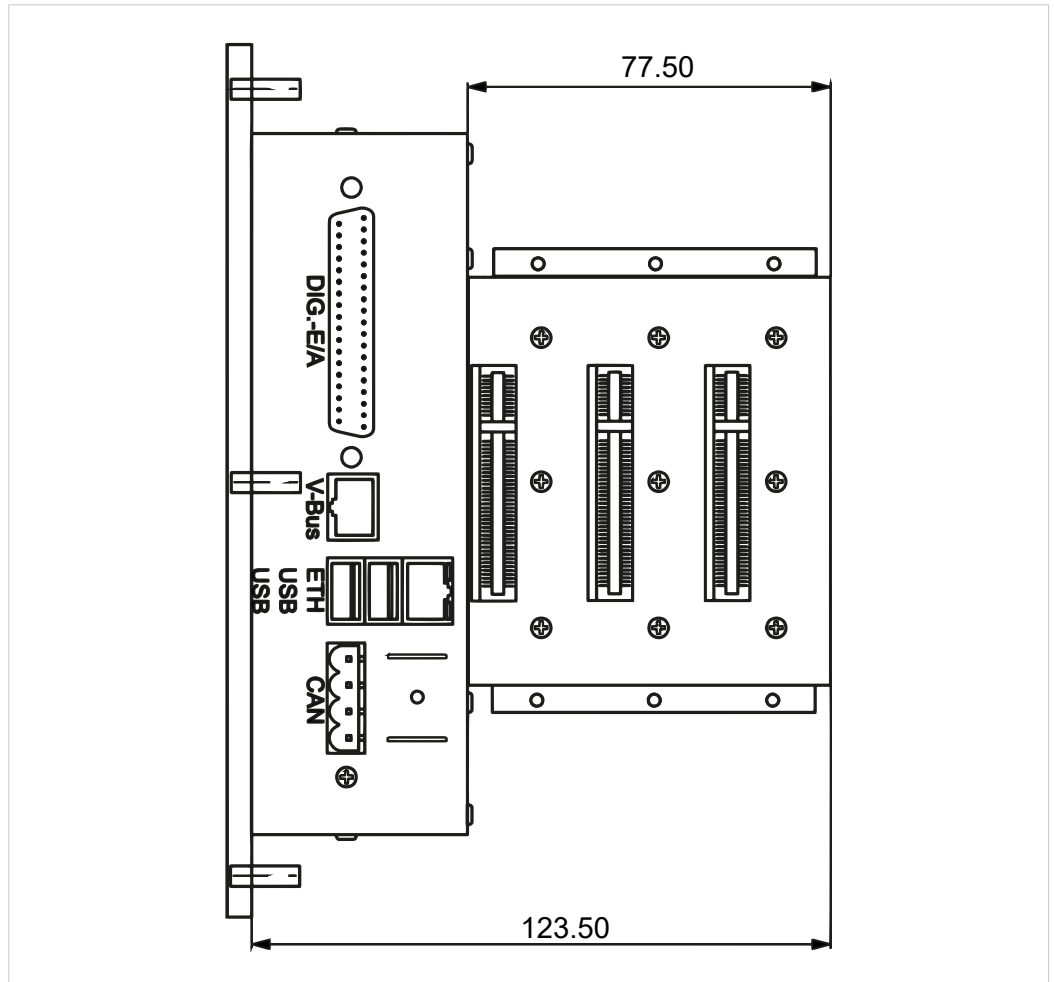

Fig. 2 Dimensions of installation housing

4.2.2 Hole pattern of installation housing (rear view)

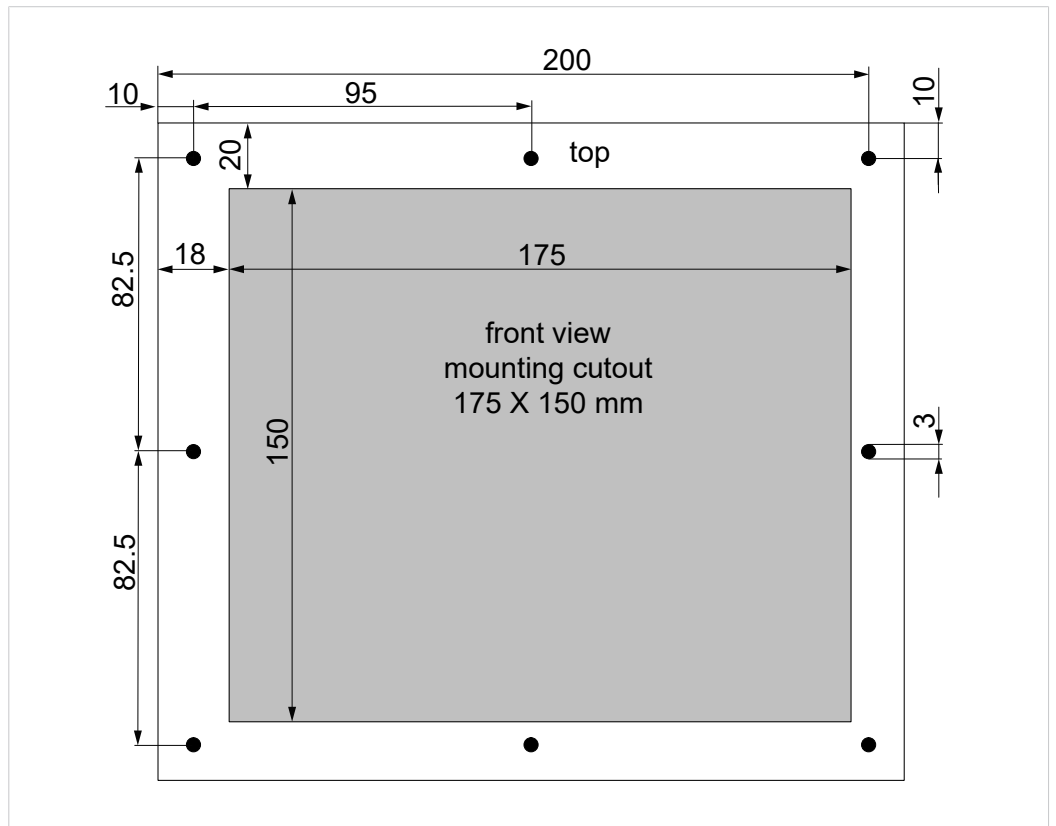

Fig. 3 Hole pattern of installation housing (rear view)

4.2.3 Dimensions of wall/table housing

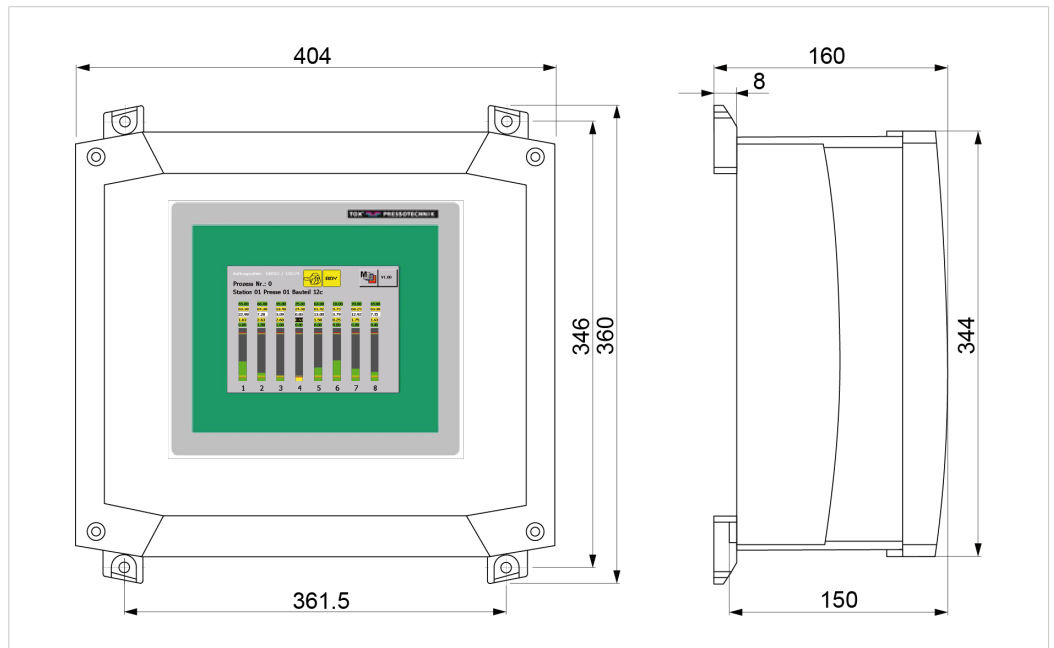

Fig. 4 Dimensions of wall/table housing

4.3 Power supply

Description	Value
Input voltage	24 V/DC, +/- 25% (incl. 10% residual ripple)
Current consumption	≤ 1 A
Wall housing	24 V DC (M12 connector strip)

Pin assignment installation housing

	voltage	Type	Description
	0 V DC	I	24 V supply voltage
	PE	I	PE
	24 V DC	I	24 V supply voltage

Pin assignment wall housing

PIN	voltage	Type	Description
1	24 V DC	I	24 V supply voltage
2	-	-	not occupied
3	0 V DC	I	24 V supply voltage
4	-	-	not occupied
5	PE	I	PE

4.4 Hardware configuration

Description	Value
Processor	ARM9 processor, frequency 200 MHz, passively cooled
RAM	1 x 256 MB CompactFlash (can be expanded to 4 GB) 2 MB boot flash 64 MB SDRAM
Data storage	1024 kB RAM, remanent
Real-time clock / accuracy	At 25°C: $\leq \pm 1$ s / day, at 10 to 70°C: $\leq + 1$ s to 11 s / day
Display	TFT, backlit, 5.7" graphics-capable TFT LCD VGA (640 x 480) Backlit LED, switchable via software Contrast 300:1 Luminosity 220 cd/m ² Viewing angle vertical 100°, horizontal 140° Analog resistive, color depth 16-bit
Interface extensibility	1 x slot for back plane 1 x keyboard interface for max. 64 buttons with LED
Buffer battery	Lithium cell, pluggable Battery type Li 3 V / 950 mAh CR2477N Buffer time at 20°C typically 5 years Battery monitoring typically 2.65 V Buffer time for battery change min. 10 minutes Order number: 300215

4.5 Connections

Description	Value
Digital inputs	16
Digital outputs	8
CAN interface	1
Ethernet interface	1
Combined RS232/485 interface RJ45	1
USB interfaces 2.0 host	2
USB device	1
CF memory card	1

4.5.1 Digital inputs

Description	Value
Input voltage	Rated voltage: 24 V (permissible range: - 30 to + 30 V)
Input current	At rated voltage (24 V): 6.1 mA
Delay time of standard inputs	$t_{\text{LOW-HIGH}}$: 3.5 ms $t_{\text{HIGH-LOW}}$: 2.8 ms
Input voltage	LOW level: ≤ 5 V HIGH level: ≥ 15 V
Input current	LOW level: ≤ 1.5 mA HIGH level: ≥ 3 mA
Input impedance	3.9 k Ω

Tab. 2 16 digital inputs, isolated

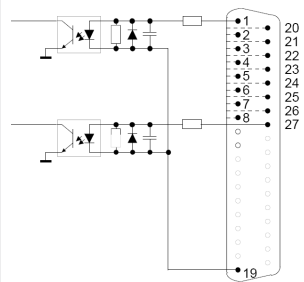
	Pin	OK	Standard CEP 400T	CEP 200 IO (Option, see Networking via Ethernet (Option), Page 18)
	1	I 0	Program bit 0	Measure
	2	I 1	Program bit 1	Reserve
	3	I 2	Program bit 2	Test plan selection bit 1
	4	I 3	Program bit 3	Test plan selection bit 2
	5	I 4	Program strobe	Test plan selection bit 2
	6	I 5	Offset external	Test plan selection cycle
	7	I 6	Start measurement	Error reset
	8	I 7	Start measurement channel 2 (only 2-channel device)	
	19	0 V	0 V external	Reserve
	20	I 8	HMI lock	Reserve
	21	I 9	Error reset	Reserve
	22	I 10	Program bit 4	Reserve
	23	I 11	Program bit 5	Reserve
	24	I 12	Reserve	Reserve
	25	I 13	Reserve	Reserve
26	I 14	Reserve	Reserve	
27	I 15	Reserve	Reserve	

Tab. 3 Built-in version: Digital inputs I0 – I15 (37-pin connector)

On devices with field bus interface, the outputs are written on both the digital outputs and the field bus outputs. Whether the inputs are read on the digital inputs or on the field bus inputs is selected in menu "Additional\Communication parameters\Field bus parameters".

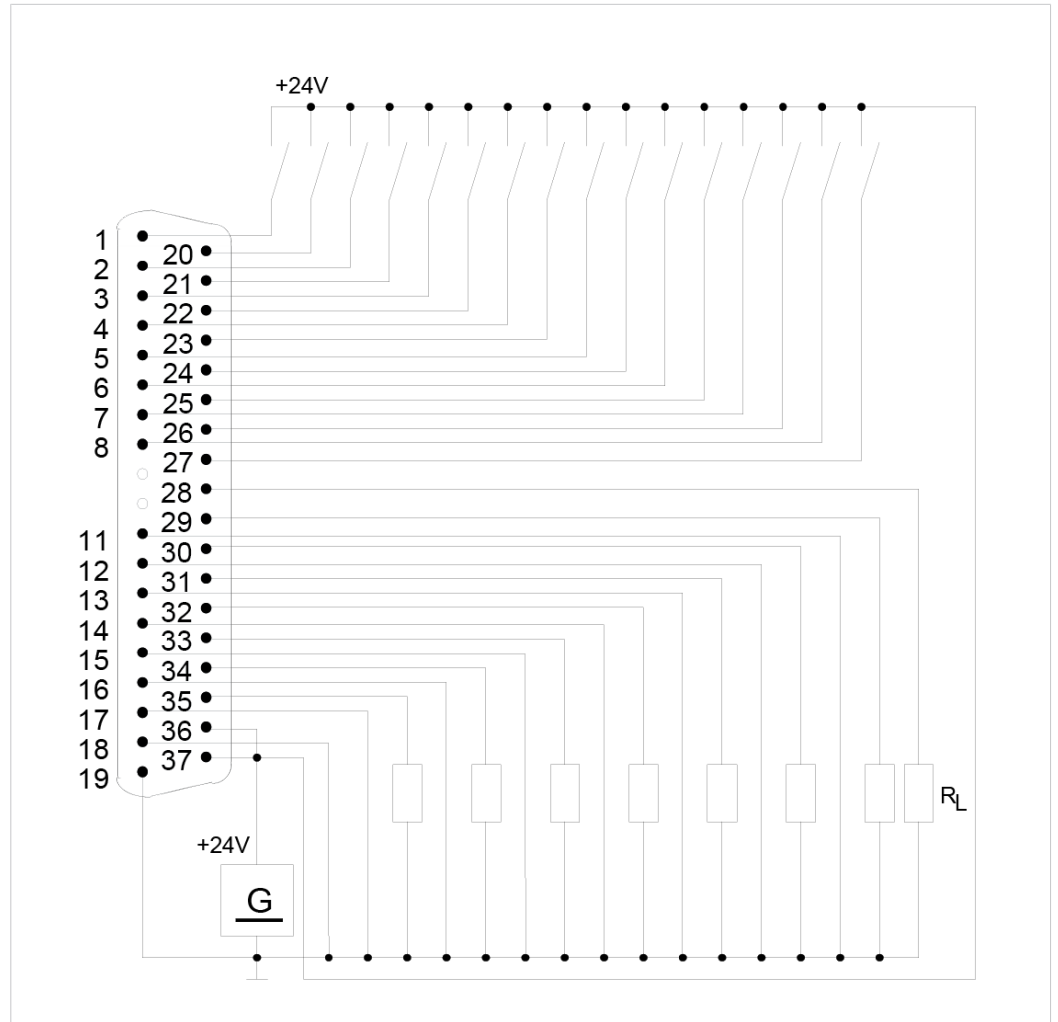

Fig. 5 Connection example of digital inputs / outputs

Pin, D-SUB 25	OK	Color code	Standard CEP 400T	CEP 200 IO (Option, see Networking via Ethernet (Option), Page 18)
14	I0	White	Program bit 0	Measure
15	I1	Brown	Program bit 1	Reserve
16	I2	GREEN	Program bit 2	Test plan selection bit 1
17	I3	YELLOW	Program bit 3	Test plan selection bit 2
18	I4	*Grey	Program strobe	Test plan selection bit 4

Pin, D-SUB 25	OK	Color code	Standard CEP 400T	CEP 200 IO (Option, see Networking via Ethernet (Option), Page 18)
19	I5	*White-yellow	Offset external	Test plan selection cycle
20	I6	White-grey	Start measurement	Error reset
21	I7	White-pink	Start measurement channel 2 (only 2-channel device)	Reserve
13	I8	White-red	HMI lock	Reserve
	I9		Error reset	Reserve
9	I10	White-blue	Program bit 4	Reserve
10	I11	*Brown-blue	Program bit 5	Reserve
	I12		Reserve	Reserve
22	I13	*Brown-red	Reserve	Reserve
25	I14		Reserve	Reserve
12	0 V	Brown-green	0 V external (PLC)	0 V external (PLC)
11	0 V internal	Blue	0 V internal	0 V internal
23	24 V internal	Pink	+24 V from internal (source)	+24 V from internal (source)

Tab. 4 Wall-mounted housing: Digital inputs I0-I15 (25-pin D-sub female connector)

*25-pin line required

4.5.2 Connections

Description	Value
Load voltage V_{in}	Rated voltage 24 V (permissible range 18 V to 30 V)
Output voltage	HIGH level: min. $V_{in}-0.64$ V LOW level: max. $100 \mu A \cdot R_L$
Output current	max. 500 mA
Parallel connection of outputs possible	Max. 4 outputs with $I_{ges} = 2$ A
Short-circuit proof	Yes, thermal overload protection
Switching frequency	Resistive load: 100 Hz Inductive load : 2 Hz (dependent on inductance) Lamp load: max. 6 W Simultaneity factor 100%

Tab. 5 8 digital outputs, isolated

NOTE

Avoid reversing current

Reversing current at the outputs may damage the output drivers.

On devices with field bus interface, the outputs are written on both the digital outputs and the field bus outputs. Whether the inputs are read on the digital inputs or on the field bus inputs is selected in menu "Additional\Communication parameters\Field bus parameters".

Built-in version: digital outputs Q0 – Q7 (37-pin connector)

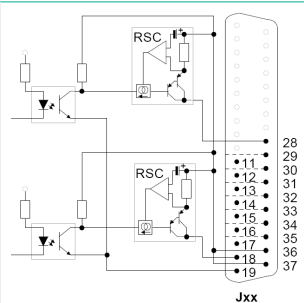
	Pin	OK	Standard CEP 400T	CEP 200 IO (Option, see Networking via Ethernet (Option), Page 18)
	19	0 V	0 V external	0 V external
	28	Q 0	OK	OK
	29	Q 1	NOK	NOK
	30	Q 2	Channel 2 OK (only 2-channel device)	Delivery cycle ready for measurement
	31	Q 3	Channel 2 NOK (only 2-channel device)	
	32	Q 4	Program ACK	Reserve
	33	Q 5	Ready for op.	Reserve
	34	Q 6	Measure active	Reserve
	35	Q 7	Measurement in progress channel 2 (only 2-channel device)	Reserve
	36	+24 V	+24 V external	+24 V external
37	+24 V	+24 V external	+24 V external	

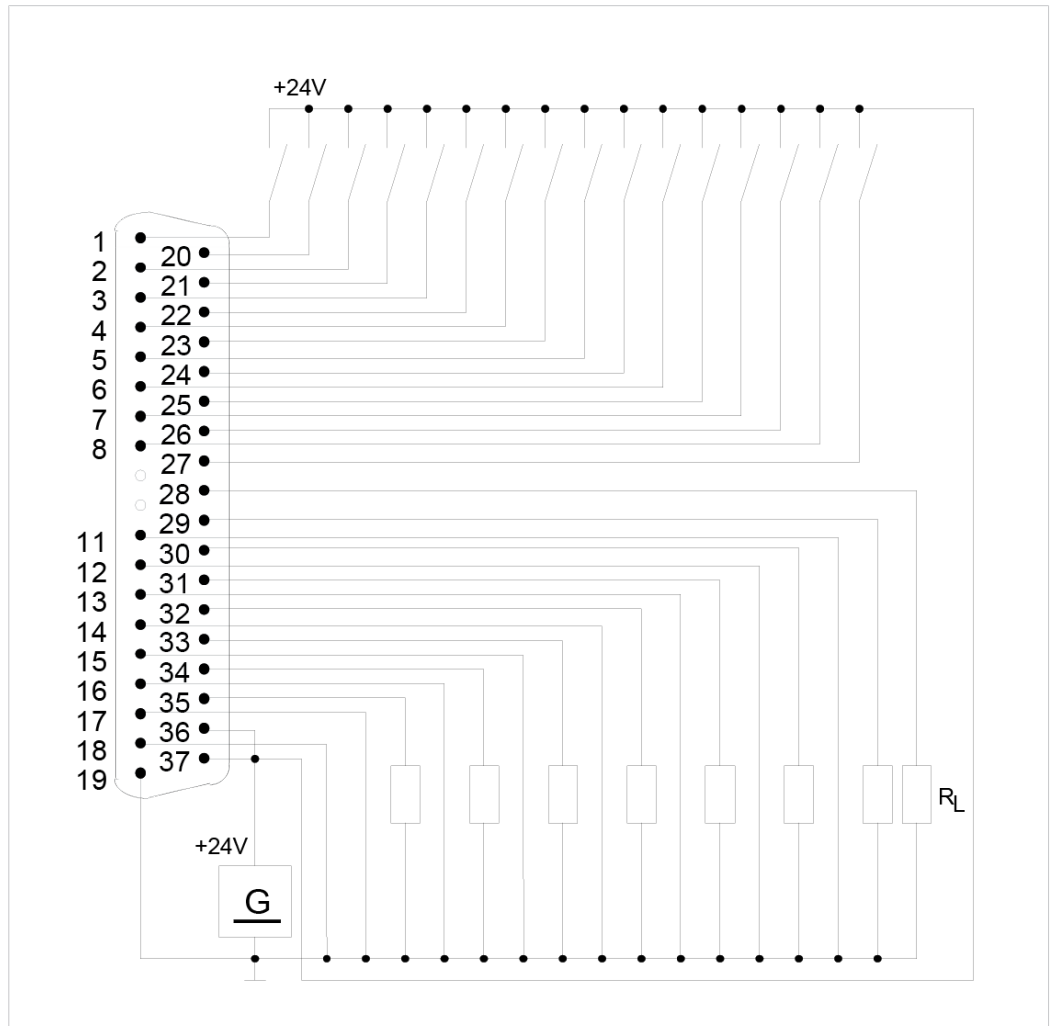

Fig. 6 Connection example of digital inputs / outputs

Wall-mounted housing: digital outputs Q0-Q7 (25-pin D-sub female connector)

Pin, D-SUB 25	OK	Color code	Standard CEP 400T	CEP 200 IO (Option, see Networking via Ethernet (Option), Page 18)
1	Q0	Red	OK	OK
2	Q1	Black	NOK	NOK
3	Q2	Yellow-brown	Channel 2 OK (only 2-channel device)	Delivery cycle
4	Q3	Violet	Channel 2 NOK (only 2-channel device)	Ready for measurement
5	Q4	Grey-brown	Program selection ACK	Reserve
6	Q5	Grey-pink	Ready for measurement	Reserve
7	Q6	Red-blue	Measure active	Reserve
8	Q7	Pink-brown	Channel 2 measurement in progress (only 2-channel device)	Reserve
12	0 V	Brown-green	0 V external (PLC)	0 V external (PLC)
24	24 V	White-green	+24 V external (PLC)	+24 V external (PLC)

Tab. 6 Wall-mounted housing: Digital inputs I0-I15 (25-pin D-sub female connector)

Mounting version: V-Bus RS 232

Description	Value
Transmission speed	1 200 to 115 200 Bd
Connecting line	Shielded, min 0.14 mm ² Up to 9 600 Bd: max. 15 m Up to 57 600 Bd: max. 3 m

Tab. 7 1 channel, non-isolated

Description	Value		
	Min.	Type	Max. of
Output voltage	+/- 3 V	+/- 8 V	+/- 15 V
Input voltage	+/- 3 V	+/- 8 V	+/- 30 V
Output current	—	—	+/- 10 mA
Input resistance	3 kΩ	5 kΩ	7 kΩ

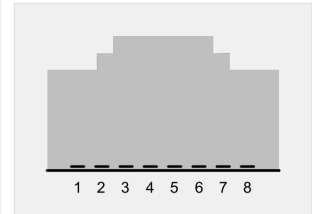
	Pin	MIO
	3	GND
	4	GND
	5	TXD
	6	RTX
	7	GND
	8	GND

Mounting version: V-Bus RS 485

Description	Value
Transmission speed	1 200 to 115 200 Bd
Connecting line	Shielded, at 0.14 mm ² : max. 300 m at 0.25 mm ² : max. 600 m
Termination	Fixed

Tab. 8 1 channel, non-isolated

Description	Value		
	Min.	Type	Max. of
Output voltage	+/- 3 V	+/- 8 V	+/- 15 V
Input voltage	+/- 3 V	+/- 8 V	+/- 30 V
Output current	—	—	+/- 10 mA
Input resistance	3 kΩ	5 kΩ	7 kΩ

Description	Value	
	Min.	Max. of
Output differential voltage	+/- 1.5 V	+/- 5 V
Input differential voltage	+/- 0.5 V	+/- 5 V
Input offset voltage		- 6 V/+ 6 V (to GND)
Output drive current		+/- 55 mA (Udiff = +/- 1.5 V)

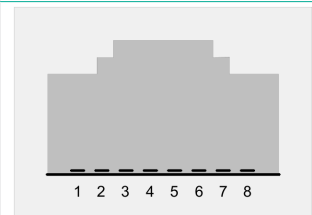
	Pin	MIO
	1	RTX
	2	RTX
	3	GND
	4	GND
	7	GND
	8	GND

NOTE
Service-Pins

All Service-Pins are only provided for factory alignment and must not be connected by the user

USB

Description	Value
Number of channels	2 x host (full-speed) 1 x device (high-speed)
USB 2.0	According to USB device specification, USB 2.0 compatible, type A and B Connection to high-powered hub/host Max. cable length 5 m

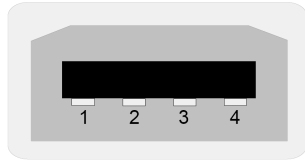
	Pin	MIO
	1	+ 5 V
	2	Data -
	3	Data +
	4	GND

Ethernet

1 channel, twisted pair (10/100BASE-T),

Transmission according to IEEE/ANSI 802.3, ISO 8802-3, IEEE 802.3u

Description	Value
Transmission speed	10/100 Mbit/s
Connecting line	Shielded at 0.14 mm ² : max. 300 m at 0.25 mm ² : max. 600 m
Length	Max. 100 mm
Cable	Shielded, impedance 100 Ω
Connector	RJ45 (modular connector)
LED status indicator	Yellow: active Green: link

Mounting version: CAN

Description	Value
Transmission speed	Cable length up to 15 m: max. 1 MBit Cable length up to 50 m: max. 500 kBit Cable length up to 150 m: max. 250 kBit Cable length up to 350 m: max. 125 kBit Number of subscribers: max. 64
Connecting line	Shielded At 0.25 mm ² : up to 100 m At 0.5 mm ² : up to 350 m

Tab. 9 1 channel, non-isolated

Description	Value	
	Min.	Max. of
Output differential voltage	+/- 1.5 V	+/- 3 V
Input differential voltage		
Recessive	- 1 V	+ 0.4 V
Dominant	+ 1 V	+ 5 V
Input offset voltage		- 6 V/+ 6 V (to CAN-GND)
Input differential resistance	20 kΩ	100 kΩ

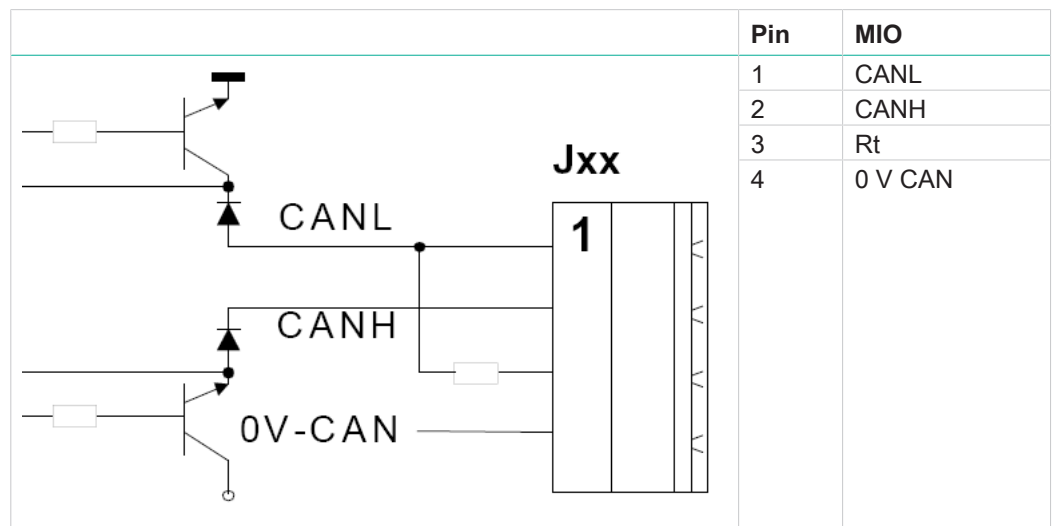

4.6 Environmental conditions

Description	Value
Temperature	Operation 0 to + 45 °C Storage - 25 to + 70 °C
Relative humidity without condensation (acc. to RH2)	5 to 90%
Vibrations according to IEC 68-2-6	15 to 57 Hz, amplitude 0.0375 mm, occasionally 0.075 mm 57 to 150 Hz, acceleration. 0.5 g, occasionally 1.0 g

4.7 Electromagnetic compatibility

Description	Value
Immunity according to	EN 61000-6-2 / EN 61131-2
Electrostatic discharge (EN 61000-4-2)	Contact: min. 8 kV Clearance: min. 15 kV
Electromagnetic fields (EN 61000-4-3)	80 MHz - 1 GHz: 10 V/m 80% AM (1 kHz) 900 MHz ±5 MHz: 10 V/m 50% ED (200 Hz)
Fast transients (EN 61000-4-4)	Power supply lines: 2 kV Process digital In-outputs: 1 kV Process analog inputs outputs: 0.25 kV Communication interfaces: 0.25 kV
Induced high frequency (EN 61000-4-6)	0.15 - 80 MHz 10 V 80% AM (1 kHz)
Surge voltage	1.2/50: min. 0.5 kV (measured at AC/DC converter input)
Emission interference according to	EN 61000-6-4 / EN 61000-4-5
RFI voltage EN 55011	150 kHz – 30 MHz (Group 1, Class A)
RFI emissions EN 50011	30 MHz – 1 GHz (Group 1, Class A)

Tab. 10 Electromagnetic compatibility in line with EC directives

4.8 Sensor Analog Standard Signals

Here a force sensor is connected that sends out a 0-10 V signal. The input is selected in menu "Configuration"(see [Configuration, Page 60](#)).

Description	Value
Nominal force or nominal distance	Adjustable via the menu
A/D converter	12 bit \pm 4096 steps
Nominal load of resolution	4096 steps, 1 step (bit) = nominal load / 4096
Accuracy of measurement	1 %
Max. sampling rate	2000 Hz (0.5 ms)

4.9 Measuring sensor supply voltage

Description	Value
Auxiliary voltage	+24 V \pm 5 %, max. 100 mA
Reference voltage	10 V \pm 1% nominal signal: 0 – 10

24 V and 10 V are available for the power supply of the measuring sensor. They are to be wired according to the type of sensor.

4.10 Screw sensor with standard signal output

The input is selected in menu "Configuration\Force sensor configuration"(see [Configuring the force sensor, Page 62](#)).

Description	Value
Tare signal	0 V = Zero adjustment active, the force sensor should be off-load here. >9 V = measuring mode, zero adjustment stopped.

For sensors that can perform an internal offset (e.g. TOX®screw sensor) a signal is available that tells the sensor when the offset adjustment is to be carried out.

The zero adjustment is activated with "Start measurement", and that is why it should be ensured that the measurement is started before the press / clinching tongs are closed!

4.11 DMS signals

Force measuring via DMS force transducer. The input is selected in menu "Configuration\Force sensor configuration"(see [Configuring the force sensor, Page 62](#)).

Description	Value
Nominal force	adjustable
Nominal stroke	see Setting Nominal Force / Nominal Distance Parameters.
A/D converter	16 bit \pm 65536 steps
Nominal load of resolution	65536 steps, 1 step (bit) = nominal load / 65536
Gain error	± 0.5 %
Max. sampling rate	2000 Hz (0.5 ms)
Bridge voltage	5 V
Characteristic value	Adjustable



Adjustment value

The entry 'Nominal force' must match the nominal value of the force sensor used. See the data sheet of the force sensor.

4.11.1 Built-in version: pin assignment, analog standard signals

One Sub-D 15-pole female connector each (designation analog I/O) is available for 4 measurement channels.

Pin	Type Input/Output	Analog signal
1	I	Force signal 0-10 V, channel 1 / 5 / 9
3	I	Ground force signal, channel 1 / 5 / 9
4	i	Force signal 0-10 V, channel 2 / 6 / 10
6	I	Ground force signal, channel 2 / 6 / 10
7	o	Analog output 1: tare +10 V
8	o	Ground
9	I	Force signal 0-10 V, channel 3 / 7 / 11
10	I	Ground force signal, channel 3 / 7 / 11
11	I	Force signal 0-10 V, channel 4 / 8 / 12
12	I	Ground force signal, channel 4 / 8 / 12
13	o	Analog output 2: 0-10 V
14	o	Ground
15	o	+10 V sensor supply



Analog output 1 (pin 7)

Analog output 1 supplies +10 V during measuring mode (signal 'Start measurement' = 1).

The signal can be used to zero the measuring amplifier.

Start measurement = 1: analog output 1 = >9 V

Start measurement = 0: analog output 1: = +0 V

4.11.2 Pin assignment DMS force transducer

Only hardware model CEP400T.2X (with DMS subprint)

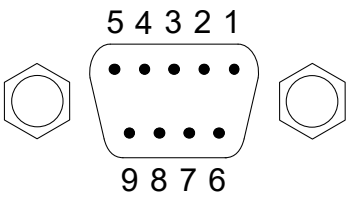
	Pin	DMS signal
	1	Measuring signal DMS +
	2	Measuring signal DMS -
	3	Reserve
	4	Reserve
	5	Reserve
	6	Supply DMS V-
	7	Sensor cable DMS F-
	8	Sensor cable DMS F+
	9	Supply DMS V+

Tab. 11 9-pole sub-D socket board DMS0 or DMS1

When connecting the DMS using the 4-conductor technique, pins 6 and 7 and pins 8 and 9 are bridged.

4.11.3 Wall-mounted housing: pin assignment of force transducer

A 17-pin plug is available for each of 4 channels.

Pin	Signal name	Type Input/Output	Notes
1	E+ K1	o	Supply DMS V+, channel 1 / 5 / 9
2	E+ K3	o	Supply DMS V+, channel 3 / 7 / 11
3	E-K1	o	Supply DMS V-, channel 1 / 5 / 9
4	S+ K1	l	Measuring signal DMS +, channel 1 / 5 / 9
5	E+ K2	o	Supply DMS V+, channel 2 / 6 / 10
6	S- K1	l	Measuring signal DMS -, channel 1 / 5 / 9
7	S+ K2	l	Measuring signal DMS +, channel 2 / 6 / 10
8	E- K2	o	Supply DMS V-, channel 2 / 6 / 10
9	E- K3	o	Supply DMS V-, channel 3 / 7 / 11
10	S- K2	l	Measuring signal DMS -, channel 2 / 6 / 10
11	S+ K3	l	Measuring signal DMS +, channel 3 / 7 / 11
12	S- K3	l	Measuring signal DMS -, channel 3 / 7 / 11
13	E+ K4	o	Supply DMS V+, channel 4 / 8 / 12
14	E- K4	o	Supply DMS V-, channel 4 / 8 / 12
15	S+ K4	l	Measuring signal DMS +, channel 4 / 8 / 12
16	Reserve		
17	S- K4	l	Measuring signal DMS -, channel 4 / 8 / 12

4.12 Profibus interface

According to ISO/DIS 11898, isolated

Description	Value
Transmission speed	Cable length up to 100 m: max. 12000 kBit Cable length up to 200 m: max. 1500 kBit Cable length up to 400 m: max. 500 kBit Cable length up to 1000 m: max. 187.5 kBit Cable length up to 1200 m: max. 93.75 kBit Wire cross-section min. 0.34 mm ² Wire diameter 0.64 mm
Connecting line	Shielded At 0.25 mm ² : up to 100 m At 0.5 mm ² : up to 350 m
Input offset voltage	- 7 V/+ 12 V (to GND)
Output drive current	-/- 55 mA (Udiff = +/- 1.5 V)
Number of subscribers per segment	Without repeater: max. 32 With repeater: max. 126 (every repeater used reduces the max. number of subscribers)
Connecting line shielded, twisted surge impedance	135 to 165 Ω
Capacitance per unit length	< 30 pf/m
Loop resistance	110 Ω/km
Recommended cables	Fixed installation UNITRONIC®-BUS L2/FIP or UNITRONIC®-BUS L2/FIP 7-wire flexible installation UNITRONIC® BUS FD P L2/FIP
Node addresses	3 to 124

Description	Value	
	Min.	Max. of
Output differential voltage	+/- 1.5 V	+/- 5 V
Input differential voltage	+/- 0.2 V	+/- 5 V

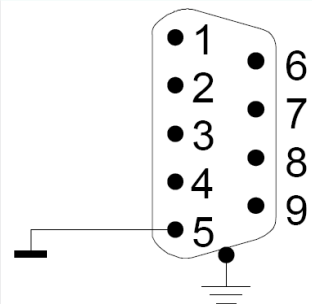
	Pin	Profibus
	3	RXD/TXD-P
	4	CNTR-P (RTS)
	5	0 V
	6	+ 5 V
	8	RXD/TXD-N

The output voltage from pin 6 for termination with a terminating resistor is + 5 V.

4.13 Fieldbus interface

Inputs I0-I15	Designation	Field bus byte	Field bus bit
I 0	Start measurement	0	0
I 1	Error reset	0	1
I 2	Offset external	0	2
I 3	Program selection strobe	0	3
I 4	Start measurement channel 2 (only 2-channel device)	0	4
I 5	Reserve	0	5
I 6	Reserve	0	6
I 7	Reserve	0	7
I 8	Program bit 0	1	0
I 9	Program bit 1	1	1
I 10	Program bit 2	1	2
I 11	Program bit 3	1	3
I 12	Program bit 4	1	4
I 13	Program bit 5	1	5
I 14	HMI lock	1	6
I 15	Reserve	1	7

Tab. 12 Data length: Byte 0-3

Outputs Q0-Q31	Designation	Field bus byte	Field bus bit
Q 0	OK	0	0
Q 1	NOK	0	1
Q 2	Ready for op.	0	2
Q 3	Program selection ACK	0	3
Q 4	Measure active	0	4
Q 5	Channel 2 OK (only 2-channel device)	0	5
Q 6	Channel 2 NOK (only 2-channel device)	0	6
Q 7	Measurement in progress channel 2 (only 2-channel device)	0	7
Q 8	Channel 1 OK	1	0
Q 9	Channel 1 NOK	1	1
Q 10	Channel 2 OK	1	2
Q 11	Channel 2 NOK	1	3
Q 12	Channel 3 OK	1	4
Q 13	Channel 3 NOK	1	5
Q 14	Channel 4 OK	1	6
Q 15	Channel 4 NOK	1	7
Q 16	Channel 5 OK	2	0
Q 17	Channel 5 NOK	2	1
Q 18	Channel 6 OK	2	2
Q 19	Channel 6 NOK	2	3
Q 20	Channel 7 OK	2	4
Q 21	Channel 7 NOK	2	5
Q 22	Channel 8 OK	2	6

Outputs Q0-Q31	Designation	Field bus byte	Field bus bit
Q 23	Channel 8 NOK	2	7
Q 24	Channel 9 OK	3	0
Q 25	Channel 9 NOK	3	1
Q 26	Channel 10 OK	3	2
Q 27	Channel 10 NOK	3	3
Q 28	Channel 11 OK	3	4
Q 29	Channel 11 NOK	3	5
Q 30	Channel 12 OK	3	6
Q 31	Channel 12 NOK	3	7

Format of final values via field bus (bytes 4 – 39):

The end values are written on bytes 4 to 39 on the field bus (if this function is activated).

BYTE	Designation
4 to 7	Running number
8	Process number
9	Status
10	Second
11	Minute
12	Hour
13	Day
14	Month
15	Year
16, 17	Channel 1 force [kN] * 100
18, 19	Channel 2 force [kN] * 100
20, 21	Channel 3 force [kN] * 100
22, 23	Channel 4 force [kN] * 100
24, 25	Channel 5 force [kN] * 100
26, 27	Channel 6 force [kN] * 100
28, 29	Channel 7 force [kN] * 100
30, 31	Channel 8 force [kN] * 100
32, 33	Channel 9 force [kN] * 100
34, 35	Channel 10 force [kN] * 100
36, 37	Channel 11 force [kN] * 100
38, 39	Channel 12 force [kN] * 100

Tab. 13 Byte X (structure):

Status	Designation
1	Measure active
2	OK
3	NOK

4.14 Pulse diagrams

4.14.1 Measuring mode

This description applies to versions without warning limit monitoring and number of pieces monitoring.

Signal name	Type: Input "I" / Output "O"	Designation
A0	o	Part is OK (OK)
A1	o	Part is not OK (NOK)
A6	o	Measure active
A5	o	Ready for measurement (ready)
E6	I	Start measurement

Tab. 14 Basic device signals

The contacts in the plug connector depend on the shape of the housing; see pin allocation of wall-mounted housing or mounting version.

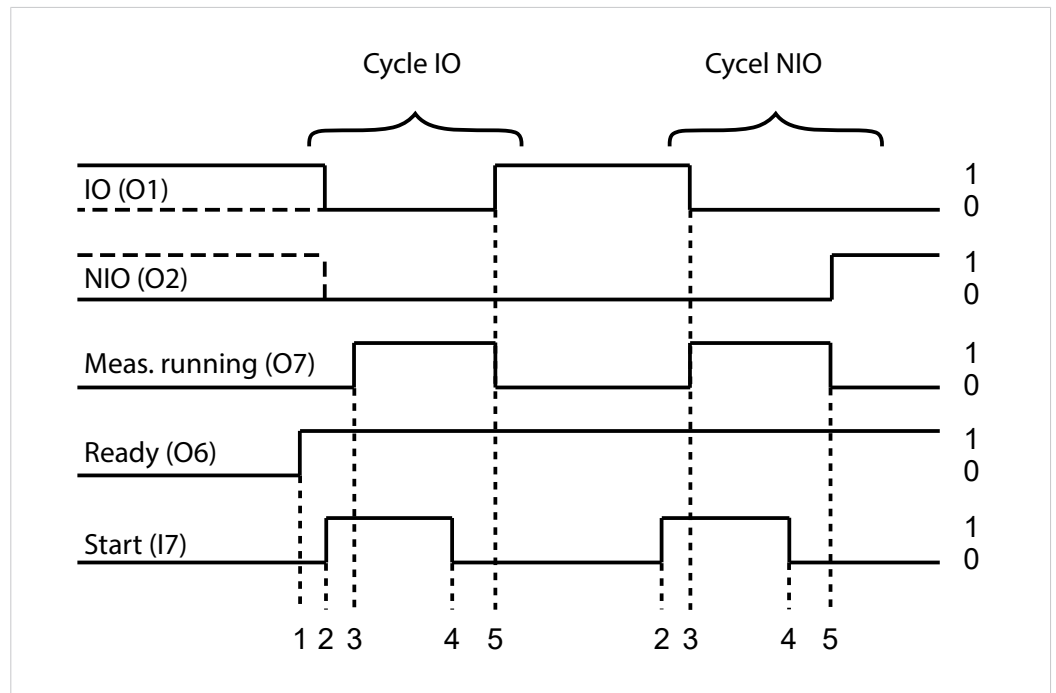

Fig. 7 Sequence without warning limit/number of pieces monitoring.

1	After it has been switched on, the device signals that it is ready for measurement by setting the >Ready> signal.
2	When closing the press the signal <Start measurement> is set.
3	The OK/NOK signal is reset. The <Measurement in progress> signal is set.

4	When the conditions for triggering the return stroke have been met and the minimum time has been reached (must be integrated in the overriding control), the 'Start' signal is reset. The measurement is evaluated when the <Start> signal is reset.
5	The <OK> or <NOK> signal is set and the <Measurement in progress> signal is reset. The OK or NOK signal remains set until the next start. When the function 'Number of pieces / Warning limit' is active, the OK signal that was not set must be used for the NOK evaluation. See the sequence at active warning limit / number of pieces.

4.14.2 Measuring mode

This description applies to versions with active warning limit monitoring and number of pieces monitoring.

Signal name	Type: Input "I" / Output "O"	Designation
A0	o	Part is OK (OK) K1
A1	o	Part is not OK (NOK) K1
A6	o	Measure K1 in progress
A5	o	Ready for measurement (ready)
E6	I	Start measurement K1

Tab. 15 Basic device signals

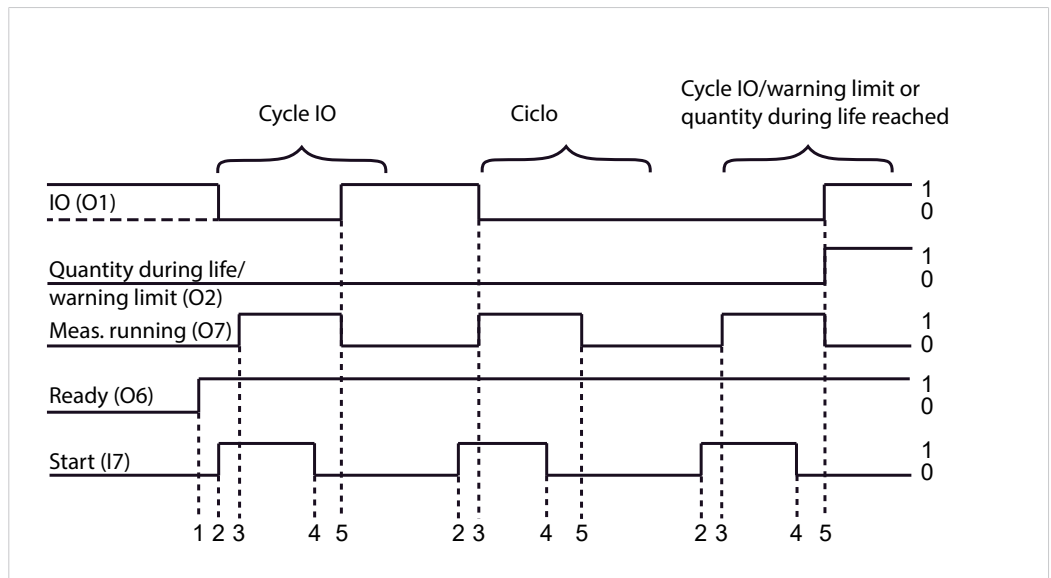

Fig. 8 Sequence with warning limit/number of pieces monitoring.

1	After it has been switched on, the device signals that it is ready for measurement by setting the >Ready> signal.
2	When closing the press the signal <Start measurement> is set.
3	The OK/NOK signal is reset. The <Measurement in progress> signal is set.

4	When the conditions for triggering the return stroke have been met and the minimum time has been reached (must be integrated in the overriding control), the 'Start' signal is reset. The measurement is evaluated when the <Start> signal is reset.
5	If the measurement lies within the programmed window, signal <OK> is set. If the measurement lies outside the programmed window, signal <OK> is not set. If the OK signal is missing it must be evaluated as NOK in the external control after a waiting period of at least 200 ms. If the warning limit or the number of pieces of a measurement channel has been exceeded in the finished cycle, the output <Warning limit/Number of pieces (NOK)> is also set. This signal can now be evaluated in the external control.



Plant control system: check the readiness of measurement

Before the command "Start measurement" it must be checked whether the CEP 400T is ready for measuring.

The process monitoring system might not be ready to measure due to a manual input or a fault. It is therefore always necessary prior to an automatic sequence to check the 'Ready to measure' output of the system controller before setting the 'Start' signal.

Signal name	Type: Input "I" / Output "O"	Designation
E0	I	Program number bit 0
E1	I	Program number bit 1
E2	I	Program number bit 2
E3	I	Program number bit 3
E10	I	Program number bit 4
E11	I	Program number bit 5
E4	I	Program number cycle
A4	o	Program number acknowledgement

Tab. 16 Automatic program selection

The program number bits 0,1,2,3,4 and 5 are set binary as test plan number from the system controller. With a rising edge of the timing signal from the system controller this information is read from the CEP 400T device and evaluated.

The reading in of the test plan selection bits is confirmed by setting the acknowledgment signal. After the acknowledgment the system controller resets the timing signal.

Selection of a test plan 0-63

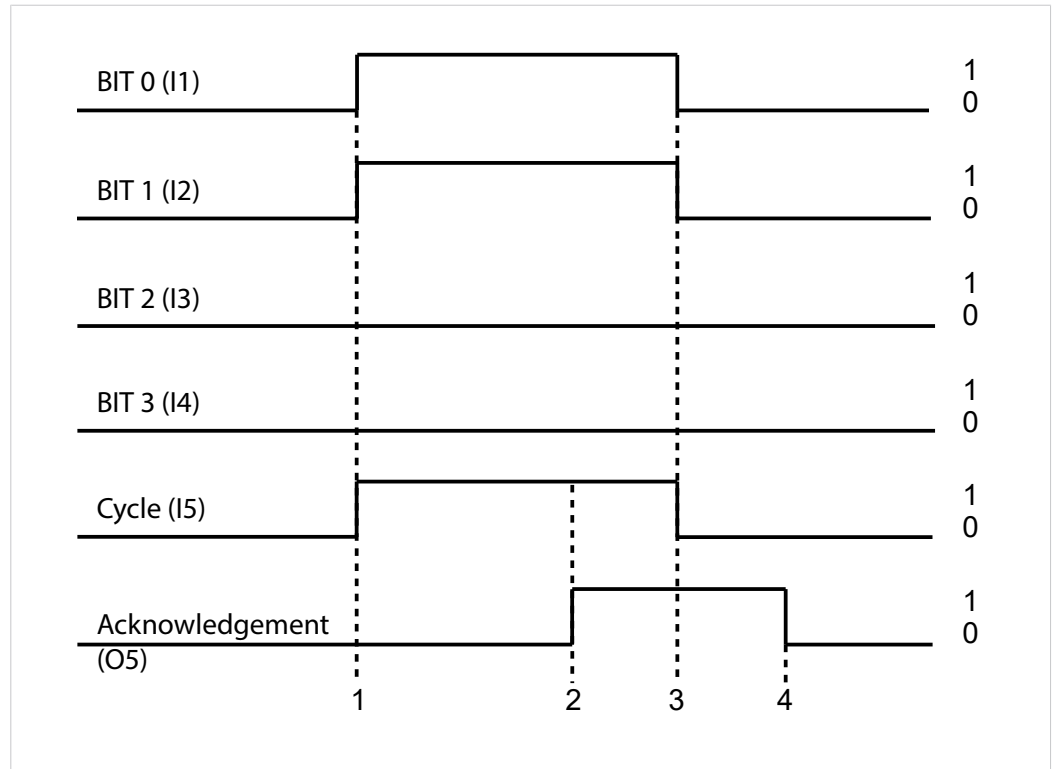

Fig. 9 Selection of a test plan 0-63

At (1) the test plan number 3 (bit 0 and 1 high) is set and selected by setting the 'Cycle' signal. At (2) the acknowledgment signal of the CEP device is set. The test plan selection cycle must remain set until the reading in of the new test plan number has been acknowledged. After the return of the timing signal the acknowledgment signal is reset.

Bit						Program no.
0	1	2	3	4	5	
0	0	0	0	0	0	0
1	0	0	0	0	0	1
0	1	0	0	0	0	2
1	1	0	0	0	0	3
0	0	1	0	0	0	4
1	0	1	0	0	0	5
0	1	1	0	0	0	6
1	1	1	0	0	0	7 etc.

Tab. 17 Valence of the test plan selection bits: test plan no. 0-63 possible

4.14.3 Offset adjustment via PLC interface force transducer channel 1 + 2

An offset adjustment for all channels can be started via the PLC interface. The handshake to start the offset adjustment via the PLC happens analog to writing a test number.

Signal name	Type: Input "I" / Output "O"	Designation
E0	I	Program number bit 0
E1	I	Program number cycle
E5	I	Offset adjustment external
A4	o	Acknowledgement of program number 3
A5	o	The device is ready for operation

Tab. 18 Basic device signals

The contacts in the plug connector depend on the shape of the housing; see pin allocation of wall-mounted housing or mounting version.

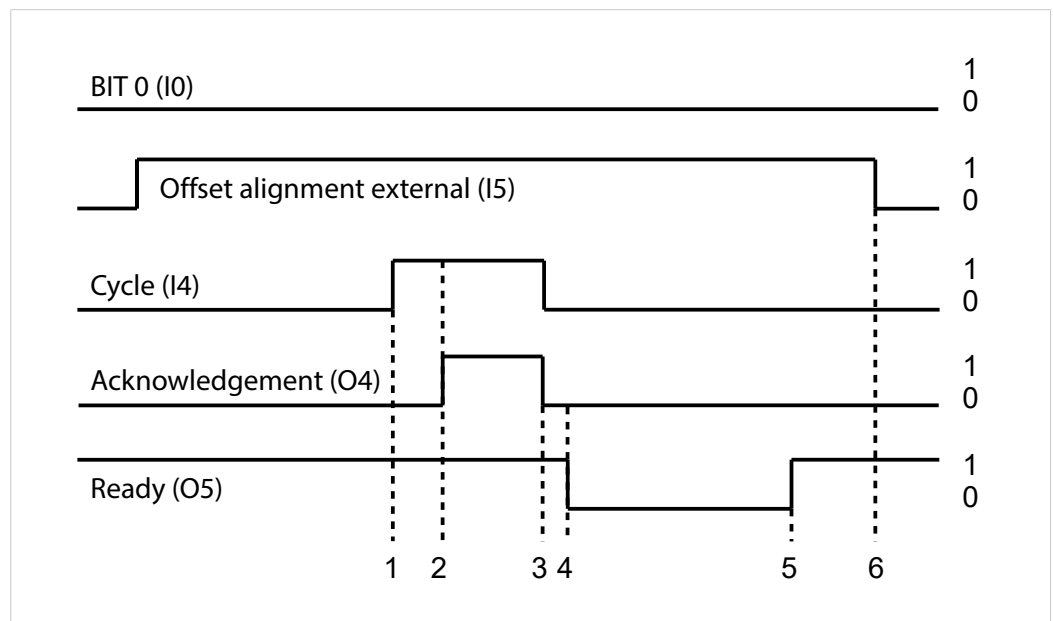

Fig. 10 External offset adjustment via PLC interface channel 1

With the end of the cycle (3) the external offset adjustment of the selected channel is started. While the offset adjustment is running (maximum of 3 seconds per channel) the <Ready> signal is reset (4). After the adjustment without error (5) the <Ready> signal is set again. The signal <External offset adjustment> (E5) must be reset again (6).

During an external offset adjustment a running measurement is interrupted. If the error "Pre-selected channel not available" or the error "Offset limit exceeded" occurs, the signal <External offset adjustment> must be cancelled. Then execute the offset adjustment anew.

5 Transport and storage

5.1 Temporary storages

- Use original packaging.
- Make sure that all electrical connections are covered to prevent dust ingress.
- Protect the display against sharp-edged objects e.g. due to cardboard or hard foam.
- Wrap the device, e.g. with a plastic bag.
- Store the device only in closed, dry, dust-free and dirt-free rooms at room temperature.
- Add drying agent to the packaging.

5.2 Dispatch for repair

To dispatch the product for repair to TOX® PRESSOTECHNIK, please proceed as follows:

- Fill in the "Accompanying repair form". This we supply in the service sector on our website or upon request via e-mail.
- Send us the completed form via e-mail.
- Then you will receive the shipping documents from us via e-mail.
- Send us the product with the shipping documents and a copy of the "Accompanying repair form".

For contact data see [Contact and source of supply, Page 10](#) or www.tox.com.

6 Commissioning

6.1 Preparing System

1. Check installation and mounting.
2. Connect required lines and devices, e.g. sensors and actuators.
3. Connect supply voltage.
4. Make sure that the correct supply voltage is connected.

6.2 Starting system

- ✓ System is prepared.
See [Preparing System, Page 48](#).
- Switch on the plant.
- ▶ The device starts the operating system and the application.
- ▶ The device switches to the start screen.

7 Operation

7.1 Monitoring operation

No operating steps are necessary during ongoing operation.



The operating procedure must be monitored constantly in order to detect faults in time.

8 Software

8.1 Function of the Software

The software fulfils the following functions:

- Clear representation of the operating parameters for operation monitoring
- Displaying of fault messages and warnings
- Configuration of the operating parameters by setting individual operating parameters
- Configuration of the interface by setting the software parameters

8.2 Software interface

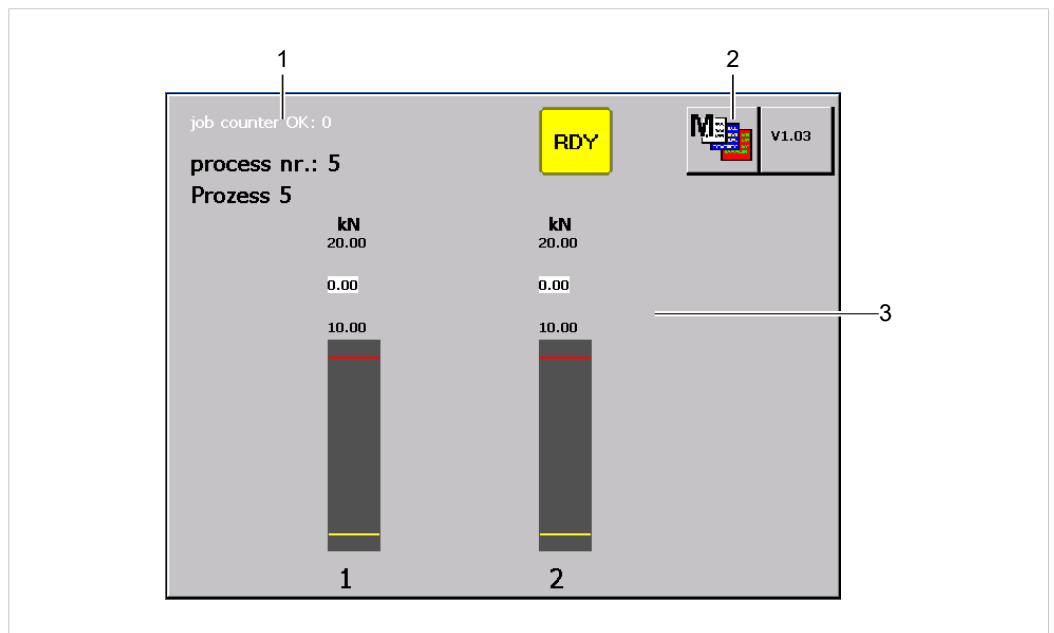

Fig. 11 Software interface

	Screen area	Function
1	Information and status bar	The information and display bar displays: <ul style="list-style-type: none"> • General information about process monitoring • Current pending messages and information for the main area displayed in the screen.
2	Menu bar	The menu bar displays the specific sub-menus for the menu currently open.
3	Menu-specific screen area	The menu-specific screen area displays the specific contents for the screen currently open.

8.3 Control elements

8.3.1 Function buttons

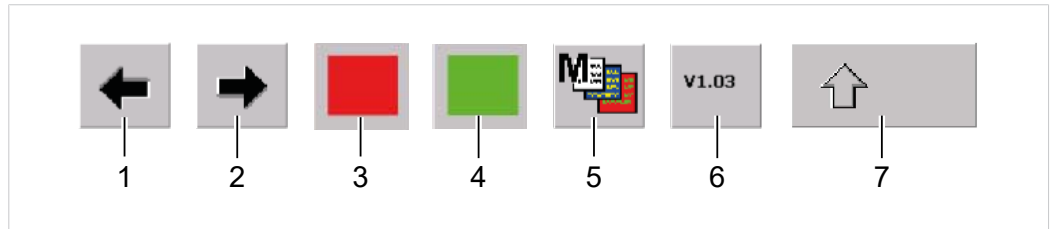

Fig. 12 Function buttons

	Display/control panel	Function
1	Button Arrow left	
2	Button Arrow right	
3	Button red	Output is deactivated.
4	Button green	Output is activated.
5	Call up "Configuration" menu	Opens the "Configuration" menu
6	Call up "Firmware version" menu	Opens the "Firmware version" menu
7	Button shift	Serves for the brief switchover of the keyboard to the second allocation level with uppercase letters and special characters.

8.3.2 Checkboxes

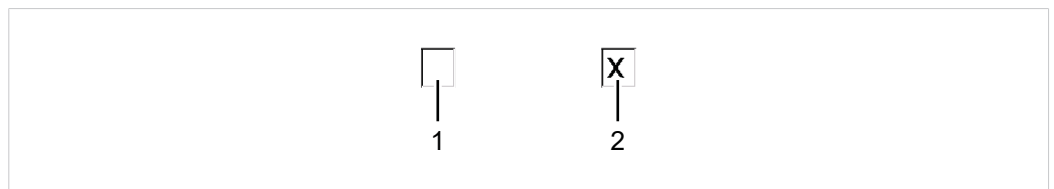

Fig. 13 Checkboxes

	Display/control panel	Function
1	Not selected	
2	Selected	

8.3.3 Input field

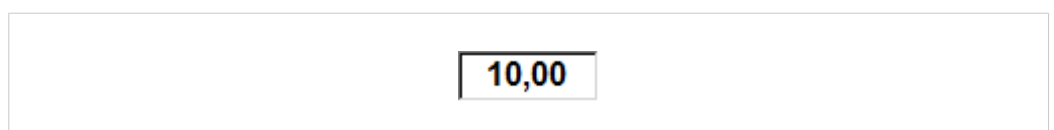

Fig. 14 Input field

The input field has two functions.

- The input field displays the value currently entered.
- Values can be entered or changed in an input field. This function is dependent on the user level and is not normally available for all user levels.

8.3.4 Dialog keyboard

Keyboard dialogs are needed for entering and changing values in input fields.

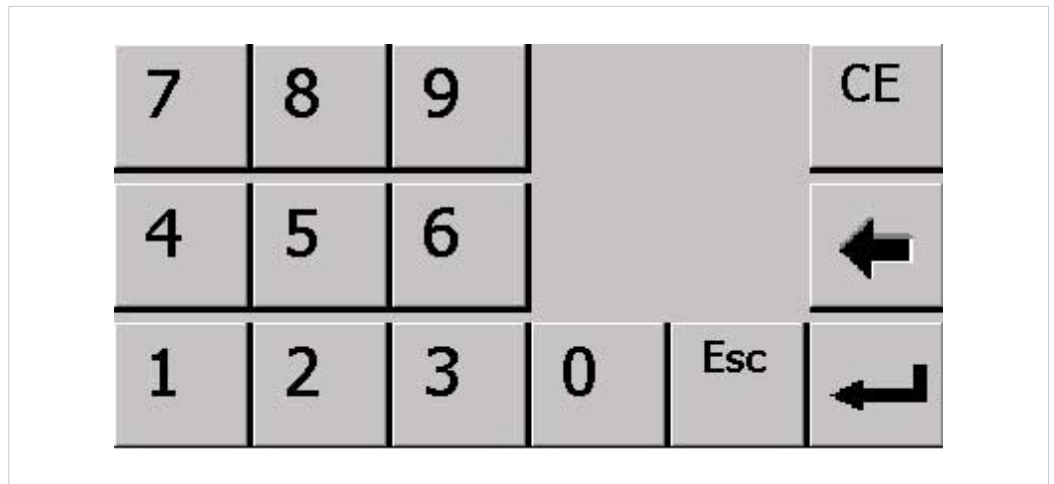

Fig. 15 Numerical keyboard

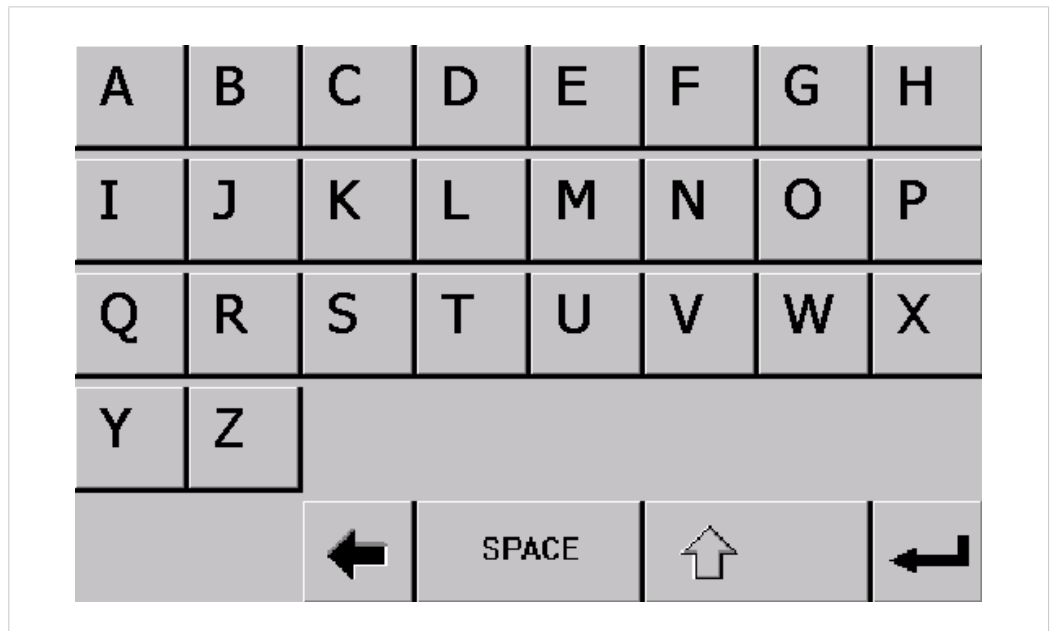

Fig. 16 Alphanumeric keyboard

It is possible to switch between three modes with the alphanumeric keyboard:

- Permanent uppercase
- Permanent lowercase
- Numbers and special characters

Activate permanent uppercase

- Keep pressing the **Shift** button until the keyboard displays uppercase letters.
 - ▷ The keyboard displays uppercase letters.





Activating permanent lowercase





- Press **Shift** button until the keyboard displays lowercase letters.
 - ▷ The keyboard displays lowercase letters.

Numbers and special characters

- Keep pressing the **Shift** button until the keyboard displays numbers and special characters.
 - ▷ The keyboard displays numbers and special characters.

8.3.5 Icons

	Display/control panel	Function
	Menu	The Configuration menu opens.
	Error reset	Resets an error. This button only appears in the event of an error.
	Firmware version	Reads the firmware version. Click on this button to read more information.
	Measure OK	The last measurement was OK.
	Measurement NOK	Last measurement was not OK. At least one evaluation criteria was violated (envelope curve, window).

	Display/control panel	Function
	Warning limit	The measurement is OK, but the set warning limit has been reached.
	Measure active	The measurement is in progress.
	Device ready to measure	The process monitoring system is ready to start a measurement.
	Device not ready to measure	The process monitoring system is not ready to start a measurement.
	Fault	Process monitoring signals a fault. The exact cause of the error is highlighted in red at the top of the screen.

8.4 Main menus

8.4.1 Select process / Enter process name

In menu "Processes -> Select process \ Enter process name" process numbers and processes can be selected.

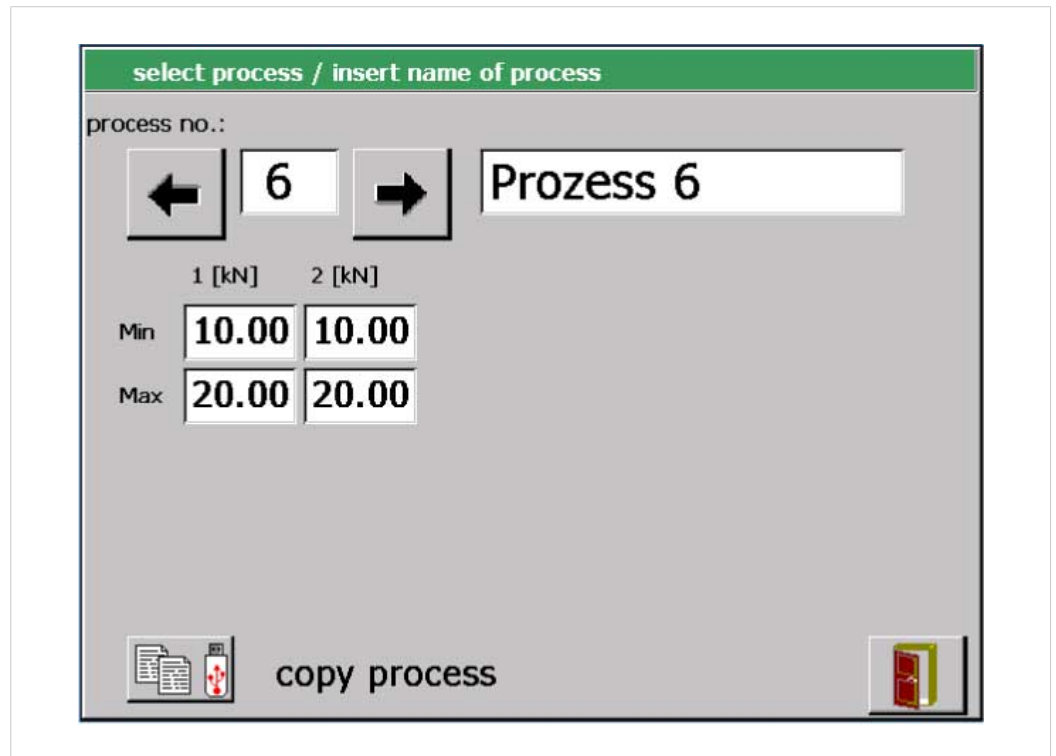



Fig. 17 Menu "Processes -> Select process \ Enter process name"

Selecting Processes

Selection by entering a Value

- ✓ The user is logged in with a suitable user level. The necessary write permissions are available.
1. Tap on **process number** input field.
 - ▷ The numerical keyboard opens.
 2. Enter process number and confirm with button ↵.

Selection by Function Buttons

- ✓ The user is logged in with a suitable user level. The necessary write permissions are available.
- ➔ Select process by tapping the  or  buttons.

Assigning Process Name

A name can be assigned for each process.

- ✓ The user is logged in with a suitable user level. The necessary write permissions are available.
1. Select process.
 2. Tap on **process name** input field.
 - ▷ The alphanumeric keyboard opens.
 3. Enter process name and confirm with the ↵ button.

Editing min/max limits

When setting up the process monitoring system, the parameters for the maximum and minimum limit values must be specified in order to evaluate the measurement values correctly.

Specifying limit values:

- ✓ TOX®-Analysis assistance is available.
1. Clinching approx. 50 to 100 piece parts at simultaneous measurement of the press forces.
 2. Checking the clinching points and piece parts (control dimension 'X', appearance of the clinching point, piece part test, etc.).
 3. Analyzing the sequence of the press forces of every measuring point (according to MAX, MIN and average value).

Determining the limit values of the press force:

1. Maximum limit value = determined max. value + 500N
2. Minimum limit value = determined min. value - 500N

- ✓ The user is logged in with a suitable user level. The necessary write permissions are available.
1. Tap the **Minor Max** input field under the channel whose value is to be changed.
 - ▷ The numerical keyboard opens.
 2. Enter the value and confirm with the ↵ button.

Copying the process

In the "Select process -> Enter process name \ Copy process" menu, source process can be copied to several target processes and parameters saved and restored again.

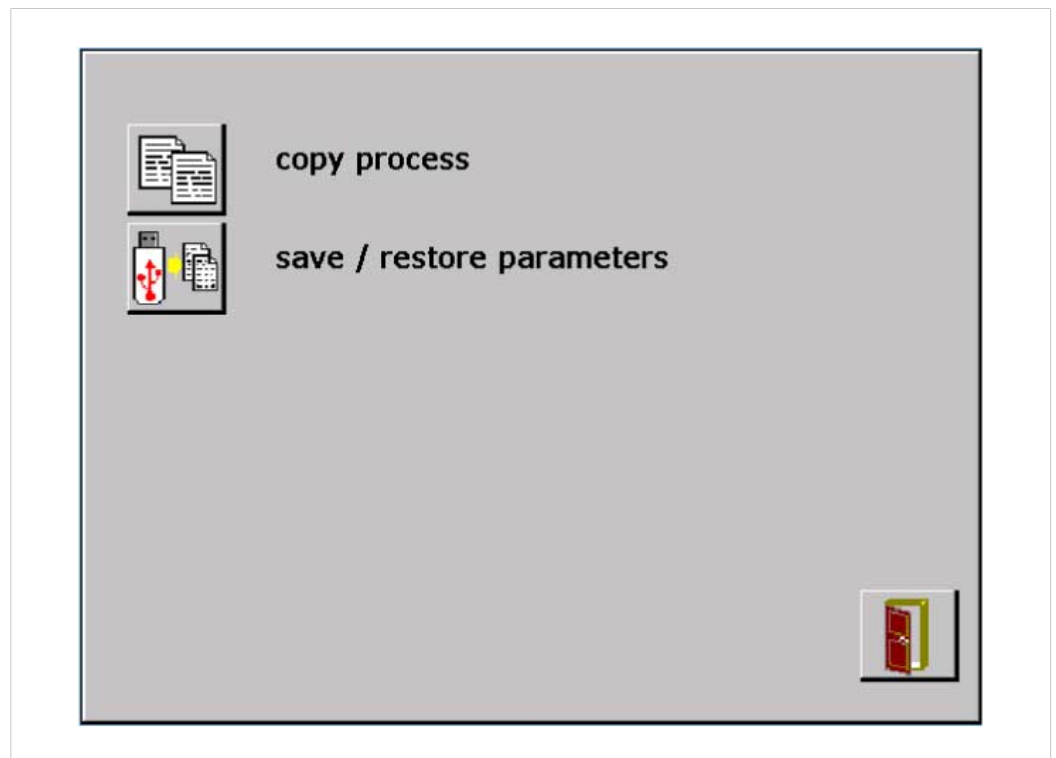

Fig. 18 "Copy process \ Save parameters" menu

Copying the process

In the "Select process -> Enter process name \ Copy proces \ Copy process" menu the min/max limits can be copied from a source process to several target processes.

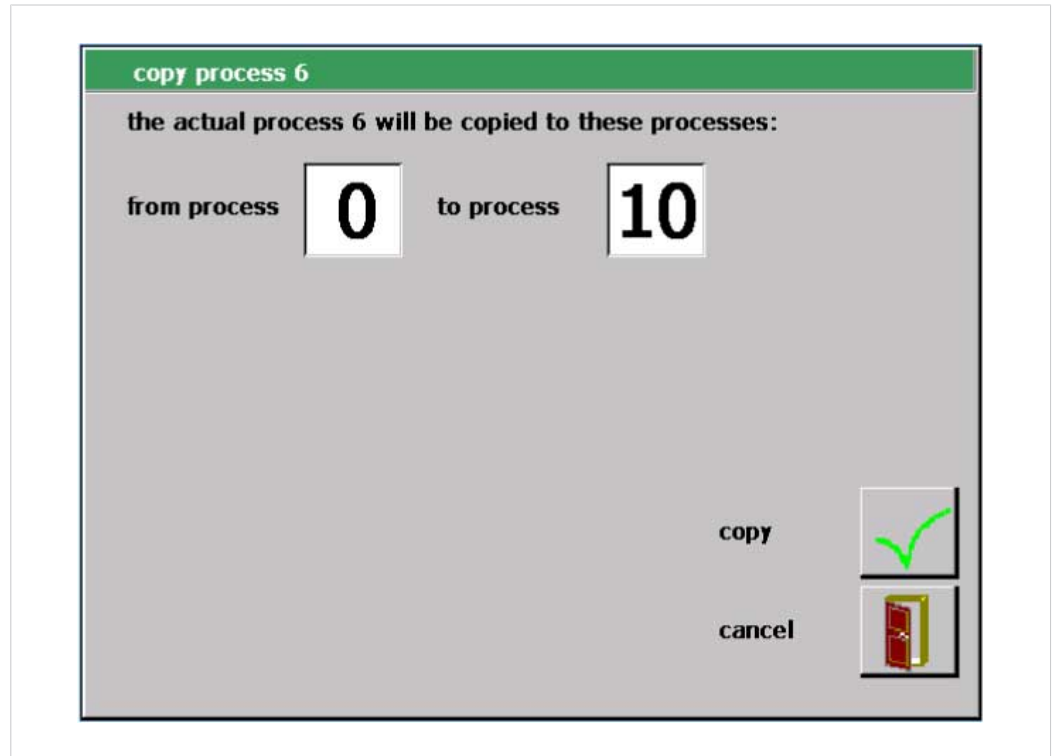

Fig. 19 Menu "Copy process"

- ✓ The user is logged in with a suitable user level. The necessary write permissions are available.
- ✓ The menu "Select process -> Enter process name \ Copy process \ Copy process" is open.

1. Tap on the **From process** input field.
 - ▷ The numerical keyboard opens.
2. Enter the number of the first process to which the values are to be copied and confirm with the ↵ button.
3. Tap the **Up to process** input field.
 - ▷ The numerical keyboard opens.
4. Enter the number of the last process to which the values are to be copied and confirm with the ↵ button.
5. **NOTE!** Data loss! The old process settings in the target process are overwritten by copying.

Start copying process by tapping on the **Accept** button.

Saving / restoring parameters

In the "Select process -> Enter process name \ Copy process -> Save \ Restore process" menu the process parameters can be copied to a USB stick or read in from a USB stick.

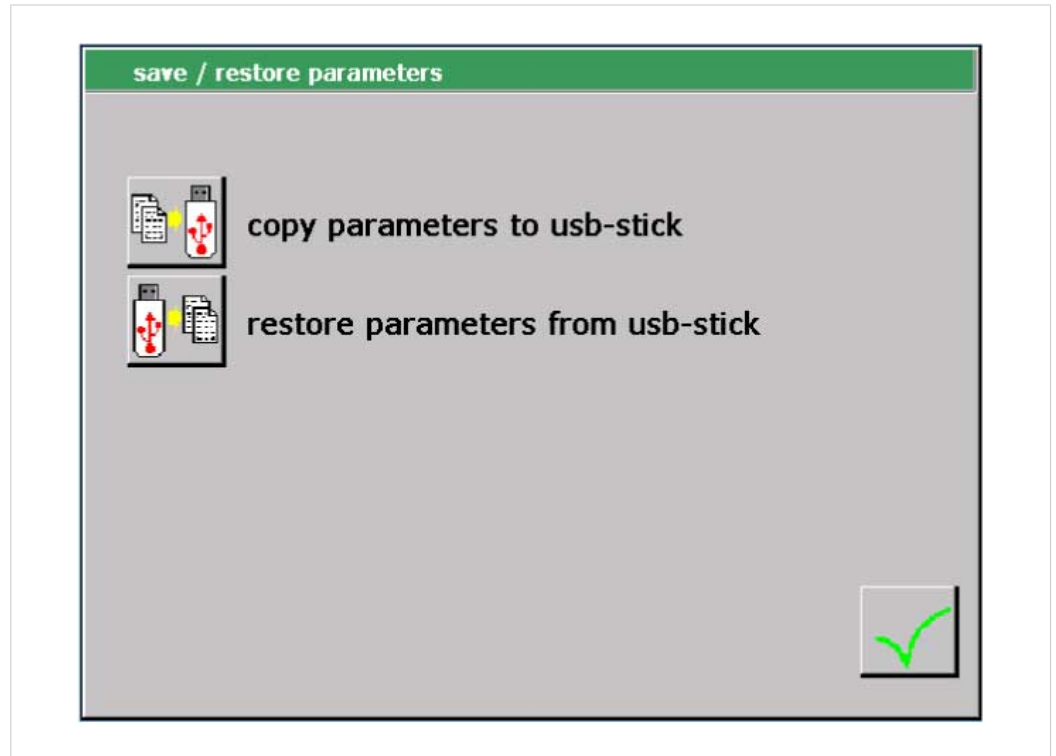

Fig. 20 "Saving / restoring parameters" menu

Copy parameters to USB stick

- ✓ The user is logged in with a suitable user level. The necessary write permissions are available.
 - ✓ The menu "Select process -> Enter process name \ Copy process \ Save / restore parameter" is open.
 - ✓ USB stick is inserted.
- ➔ Tap on **Copy parameters to USB stick** button.
- ▷ The parameters are copied on the USB stick.

Load parameters from USB stick

- ✓ The user is logged in with a suitable user level. The necessary write permissions are available.
- ✓ USB stick is inserted.

→ **NOTE!** Data loss! The old parameters in the target process are overwritten by copying.

Tap the **Load the parameters from the USB stick** button.

- ▷ The parameters are read from the USB stick.

8.4.2 Configuration

The process-dependent parameters of warning limit and force sensor are set in the "Configuration" menu.

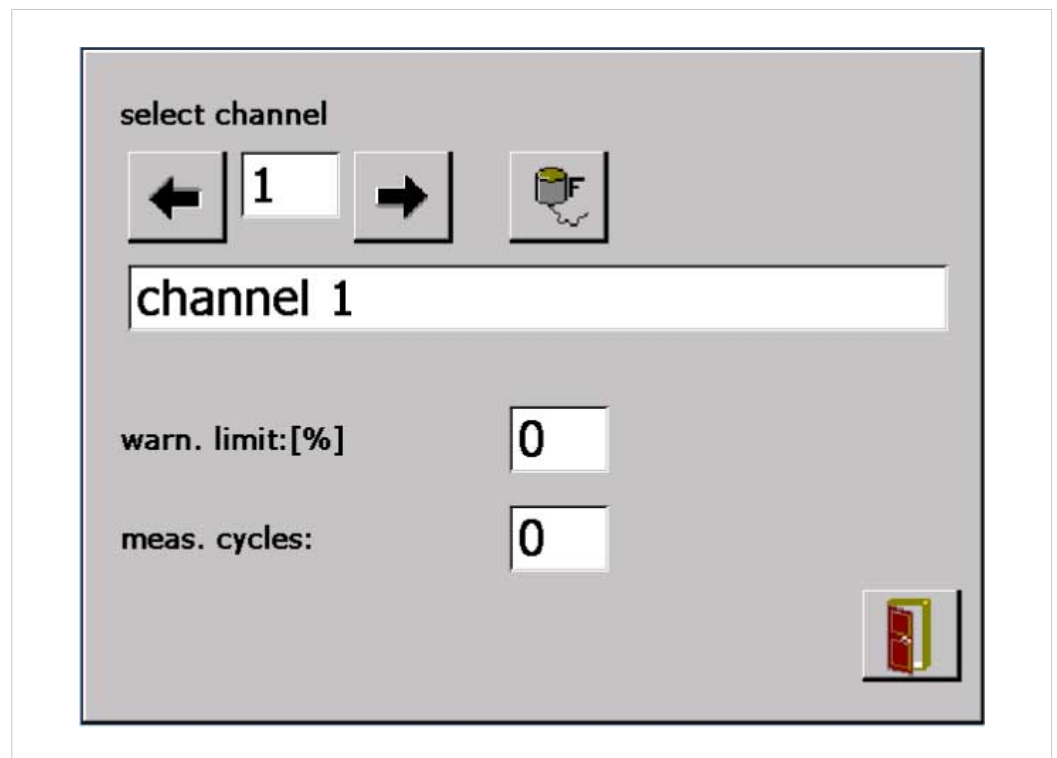

Fig. 21 "Configuration" menu

Naming the channel

- ✓ The user is logged in with a suitable user level. The necessary write permissions are available.
- 1. Tap on the **Naming** input field.
 - ▷ The alphanumeric keyboard opens.
- 2. Enter the channel (max. 40 characters) and confirm with ↵.

Setting warning limit and measuring cycles

With these settings the values are preset globally for all processes. These values must be monitored by the overriding control system.

Setting the warning limit

The value fixes the warning limit with regard to defined tolerance windows that are defined in the process.

- ✓ The user is logged in with a suitable user level. The necessary write permissions are available.
- 1. Tap on **Warning limit: [%]** input field.
 - ▷ The numerical keyboard opens.
- 2. Enter a value between 0 and 50 and confirm with ↵.

Deactivating the warning limit

- ✓ The user is logged in with a suitable user level. The necessary write permissions are available.
- 1. Tap on **Warning limit: [%]** input field.
 - ▷ The numerical keyboard opens.
- 2. Enter 0 and confirm with ↵.

Setting measuring cycles

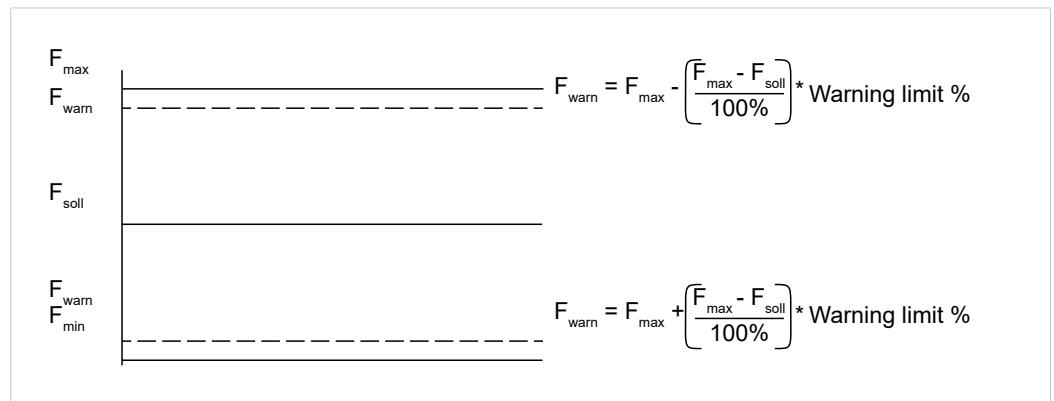

When the warning limit is activated the warning limit counter is raised by value '1' after every violation of the lower and upper warning limit. As soon as the counter reaches the value set in menu item **Measuring cycles** the signal 'Warning limit reached' is set for the relevant channel. After each further measurement the yellow symbol Warning limit message is displayed. The counter is automatically reset when a further measuring result lies within the set warning limit window. The counter is also reset after a restart of the device.

- ✓ The user is logged in with a suitable user level. The necessary write permissions are available.
1. Tap on the **Measuring cycles** input field.
 - ▷ The numerical keyboard opens.
 2. Enter a value between 0 and 100 and confirm with ↵.

Configuring the force sensor

In menu "Configuration -> Configuration of force sensor" the parameters of the force sensor are specified for the active process.

→ Open the "Configuration -> Force sensor configuration" by tapping the but-



Force sensor without DMS subprint card

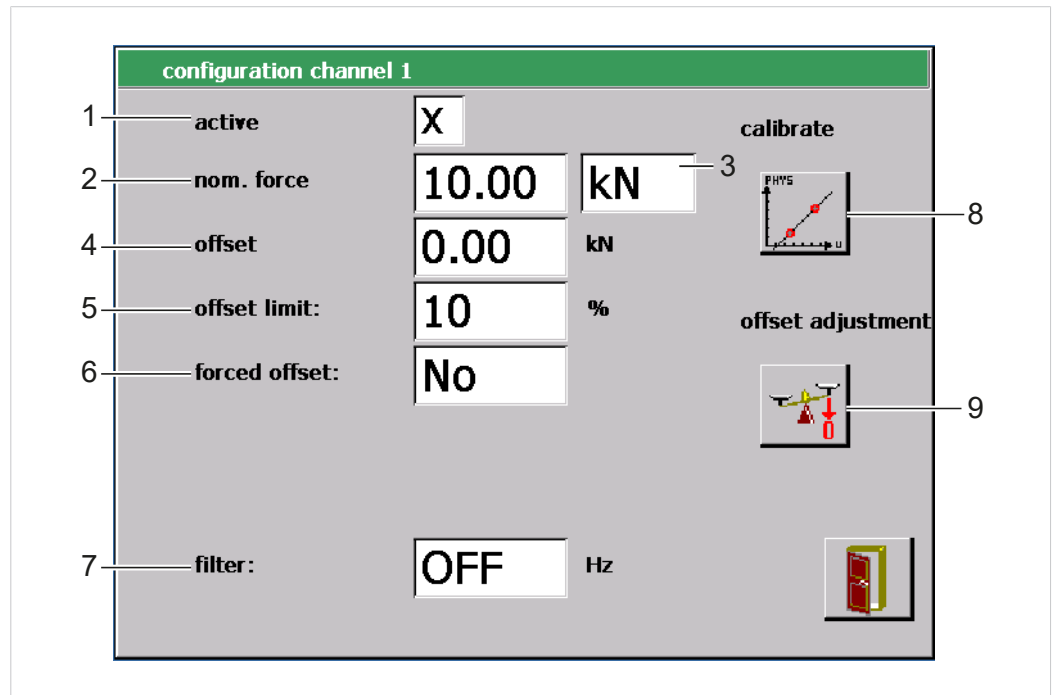

	Button, input/control panel	Function
1	Active	Activatingx or deactivatingo the selected channel. Deactivated channels are not evaluated and not displayed in the measurement menu.
2	Nominal Force	The nominal force of the force transducer corresponds to the force at a maximum measuring signal.
3	Nominal force, unit	Unit of nominal force (maximum of 4 characters)
4	Offset	Offset value of the measuring signal for adjusting a possible zero point offset of the analog measuring signal of the sensor.
5	Offset limit	Maximum tolerated force sensor offset.
6	Forced offset	NO: The process monitoring system ready to measure directly after being switched on. YES: The process monitoring system carries out an offset adjustment for the respective channel automatically after every start.
7	Filter	Limit frequency of the measurement channel
8	Calibrating	The force sensor calibration menu opens.
9	Offset adjustment	Read in the current measuring signal as offset of the force sensor.

Force sensor with DMS subprint card

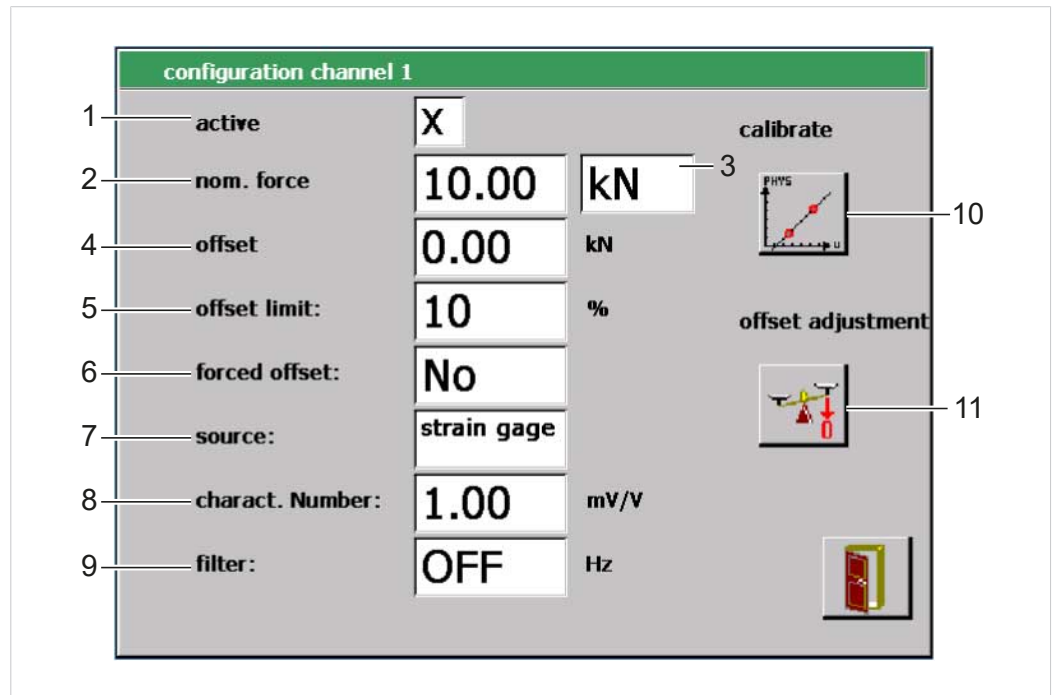

	Button, input/control panel	Function
1	Active	Activatingx or deactivatingo the selected channel. Deactivated channels are not evaluated and not displayed in the measurement menu.
2	Nominal Force	The nominal force of the force transducer corresponds to the force at a maximum measuring signal.
3	Nominal force, unit	Unit of nominal force (maximum of 4 characters)
4	Offset	Offset value of the measuring signal for adjusting a possible zero point offset of the analog measuring signal of the sensor.
5	Offset limit	Maximum tolerated force sensor offset.
6	Forced offset	NO: The process monitoring system ready to measure directly after being switched on. YES: The process monitoring system carries out an offset adjustment for the respective channel automatically after every start.
7	Source	Switchover between standard signal and DMS.
8	Nominal characteristic value	Enter the nominal value of the sensor used. See the data sheet of the sensor manufacturer.
9	Filter	Limit frequency of the measurement channel
10	Calibrating	The force sensor calibration menu opens.
11	Offset adjustment	Read in the current measuring signal as offset of the force sensor.

Setting the nominal force of the force sensor

- ✓ The user is logged in with a suitable user level. The necessary write permissions are available.
 - ✓ The "Configuration -> Force sensor configuration " menu is opened.
1. Tap on the **Nominal force** input field.
 - ▷ The numerical keyboard opens.
 2. Enter the value for the desired nominal force and confirm with ↵.
 3. If necessary: Tap on the **Nominal force, unit** input field.
 - ▷ The alphanumeric keyboard opens.
 4. Enter the value for the desired unit of the nominal force and confirm with ↵.

Adjusting the offset force sensor

The **Offset** parameter adjusts a possible zero point offset of the analog measurement sensor of the sensor.

An offset adjustment must be carried out:

- once a day or after approx. 1000 measurements.
- when a sensor has been changed.

Adjustment using Offset adjustment button

- ✓ The user is logged in with a suitable user level. The necessary write permissions are available.
 - ✓ The "Configuration -> Force sensor configuration " menu is opened.
 - ✓ Sensor is load-free during the offset adjustment.
- ➔ Tap on **Offset adjustment** button.
- ▷ The current measurement signal (V) is applied as offset.

Adjustment via direct Value Input

- ✓ The user is logged in with a suitable user level. The necessary write permissions are available.
 - ✓ The "Configuration -> Force sensor configuration " menu is opened.
 - ✓ Sensor is load-free during the offset adjustment.
1. Tap on **Offset** input field.
 - ▷ The numerical keyboard opens.
 2. Enter the zero point value and confirm with ↵.

Offset limit force sensor

Offset limit of 10% means that the "Offset" value must only reach a maximum of 10% of the nominal load. If the offset is higher, an error message appears after the offset adjustment. This, for example, can prevent that an offset is taught when the press is closed.

- ✓ The user is logged in with a suitable user level. The necessary write permissions are available.
- ✓ The "Configuration -> Force sensor configuration " menu is opened.

- ➔ Tap on the **Offset limit** input field.
 - ▷ Each tap changes the value between 10 -> 20 -> 100.

Forced offset force sensor

If the forced offset is activated, an offset adjustment is carried out automatically after the process monitoring system is switched on.

- ✓ The user is logged in with a suitable user level. The necessary write permissions are available.
- ✓ The "Configuration -> Force sensor configuration " menu is opened.

- ➔ Tap on the **Forced offset** input field.
 - ▷ Each tap changes the value from **YES** to **NO** and reverse.

Setting the force sensor filter

By setting a filter value the higher frequency deviations of the measuring signal can be filtered out.

- ✓ The user is logged in with a suitable user level. The necessary write permissions are available.
- ✓ The "Configuration -> Force sensor configuration " menu is opened.

→ Tap on the **Filter** input field.

- ▷ Each tap changes the value between **OFF, 5, 10, 20, 50, 100, 200, 500, 1000**.

Force sensor calibration

In menu "Enter Configuration -> Configuration of force sensor\Nominal force" the measured electrical signal is converted to the corresponding physical unit with the values of nominal force and offset. If the values for nominal force and offset are not known, they can be determined via the calibration. For this a 2-point calibration is carried out. The first point here can be the opened press with 0 kN force applied for example. The second point, for example, can be the closed press when 2 kN force is applied. The applied forces must be known for carrying out the calibration, for example, which can be read on a reference sensor.

→ Open the "Enter Configuration -> Force sensor configuration\Nominal force"

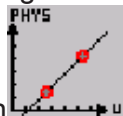

by tapping the button in "Configuration\Configuration of force sensor\".

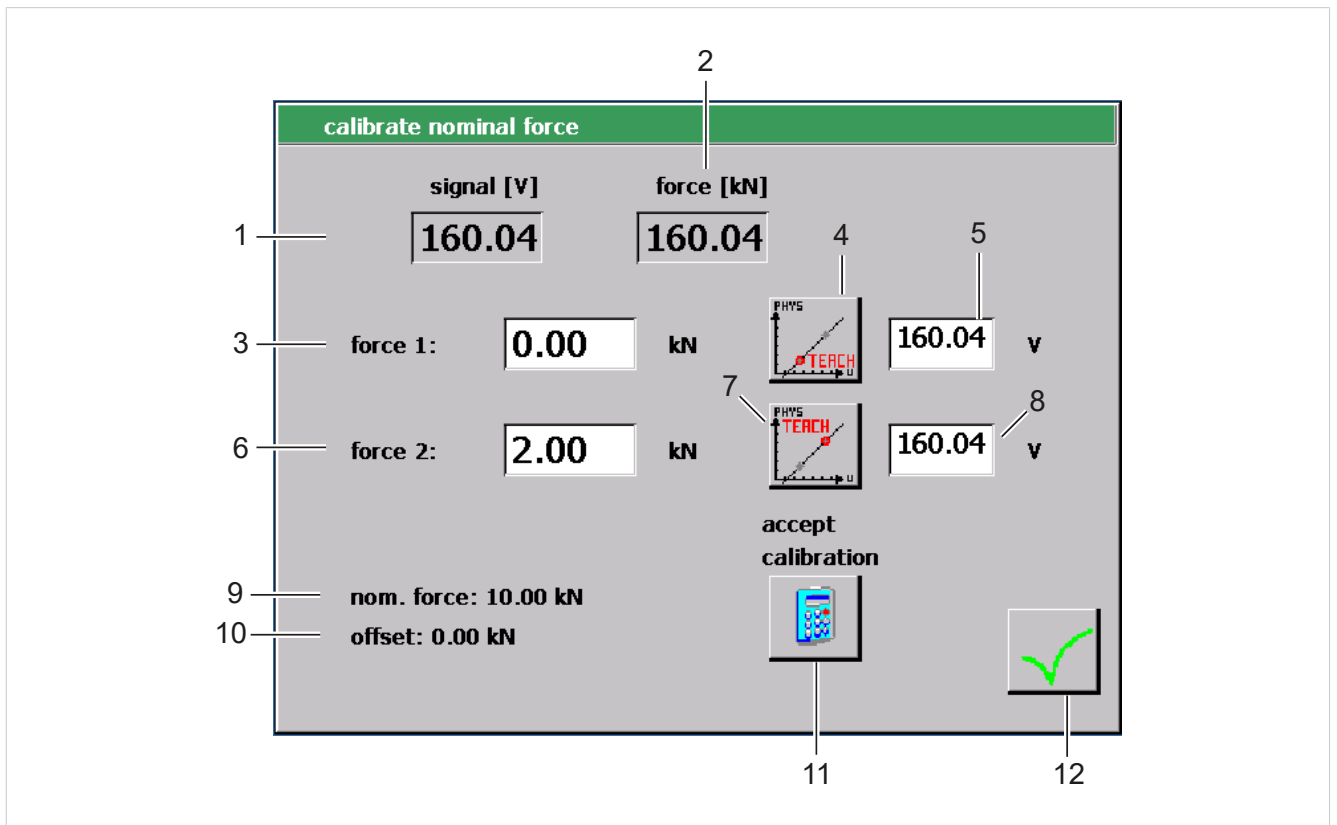

Fig. 22 "Enter Configuration -> Configuration of force sensor\Nominal force"

	Button, input/control panel	Function
1	Signal	
2	Force	
3	Force 1	
4	Teach 1	
5	Measuring value 1	Is faded in when Teach 1is tapped. Display/ Input field of measured value.
6	Force 2	
7	Teach 2	
8	Measuring value 2	Is faded in when Teach 2is tapped. Display/ Input field of measured value.
9	Nominal Force	
10	Offset	
11	Accept calibration	The calibration of the sensors is accepted.
12	Accept	Saves the changes

- ✓ The user is logged in with a suitable user level. The necessary write permissions are available.
 - ✓ The "Enter the Configuration -> Force sensor configuration\Nominal force" menu is opened.
1. Move to the first point, e.g. press opened.
 2. Determine the applied force (e.g. by a reference sensor attached temporarily to the press) and simultaneously if possible tap the **Teach 1** button for reading the applied force.
 - ▷ The applied electrical signal is read in.
 3. Tap on the **Force 1** display/input field.
 - ▷ The numerical keyboard opens.
 4. Enter the value of the measuring value of the electrical measuring signal to be displayed and confirm with ↵.
 5. Move to the second point, e.g. closing the press with a certain press force.
 6. Determine the currently applied force and simultaneously if possible tap the **Teach 2** button for reading the applied force.
 - ▷ The current electrical measuring signal is accepted and displayed in a new display/input field **Measuring value 2** next to the **Teach 2** button.
 7. Tap on the **Force 2** display/input field.
 - ▷ The numerical keyboard opens.
 8. Enter the value of the measuring value of the electrical measuring signal to be displayed and confirm with ↵.
 9. Save the changes with **Accept calibration**.
- ▶ When pressing the **Accept calibration** button the process monitoring system calculates the parameters of nominal force and offset from the the two force values and the measured electrical signals. That concludes the calibration.



By tapping the text fields **Measuring value 1** or **Measuring value 2** the values of the measured electrical signals can also be changed before tapping the **Accept calibration** button.

This should, however, only be made when the allocation of the electrical signal for force is known.

Apply configuration

If a value or a setting has been changed in menu "Configuration -> Configuration of force sensor", a request dialog is displayed when exiting the menu.

In this window the following options can be selected:

- Only for this process:
The changes only apply to the current process and overwrite the previous values/settings in the current process.
- Copy to all processes
The changes apply to all processes and overwrite the previous values/settings in all processes.
- Copy to the following processes
The changes are only accepted in the area that has been specified in fields **From process to process**. The previous values/settings are overwritten in the defined process area with the new values.
- Cancel entry:
The changes are discarded and the window is closed.

Data

In menu "Configuration -> Data\Final values" the recorded final values can become datasets. After each measurement, a final value dataset is saved.

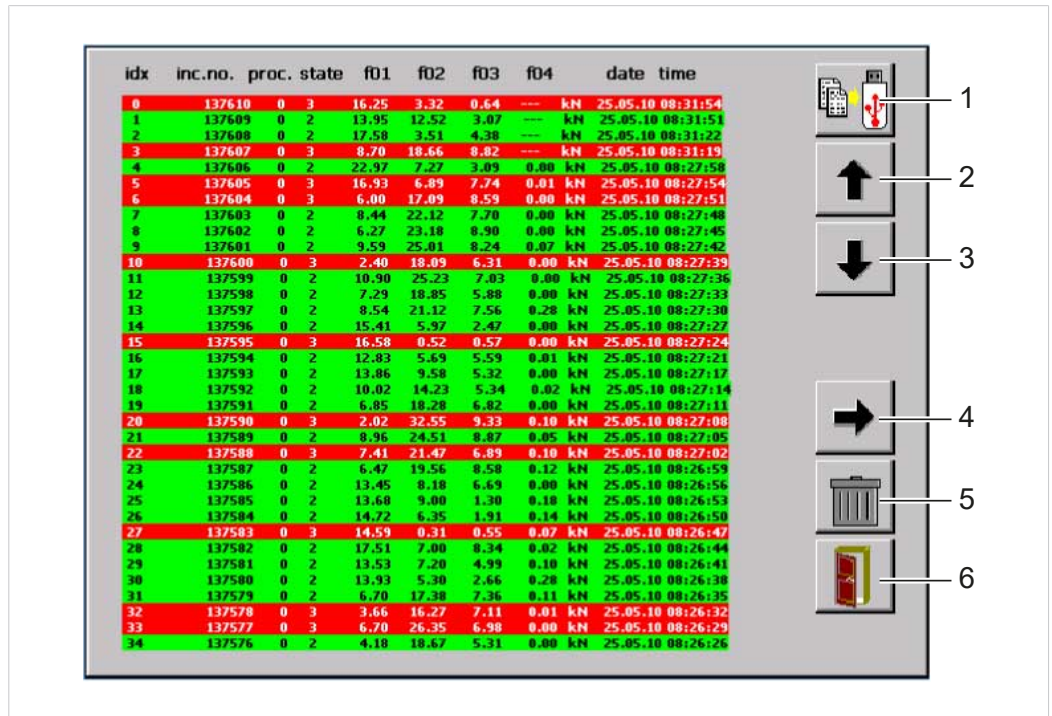

Fig. 23 Menu "Configuration \ Data\Final values"

	Button, input/display field	Function
	idx	Number of the measurement. 1000 final values are stored in a circular buffer. If 1000 final values have been stored, then with each new measurement the oldest dataset (= no. 999) is discarded and the newest is added (last measurement = no. 0).
	inc. no	Unique consecutive number. The number is counted up by value 1 after each measurement.
	proc	Assignment of the measurement to a process
	state	Status of a measurement: Green background: Measurement OK Red background: Measurement NOK
	f01 ... f12	Measured force of channels 01 to 12
	date	Date of measurement in format dd.mm.yy
	time	Time of measurement in format hh:mm:ss
1	Save on USB	By tapping on button Save on USB the last 1000 final value datasets are copied on a USB stick in folder Tox\Archive.
2	Arrow keys up	Scroll up in the screen.
3	Arrow keys down	Scroll down in the screen.
4	Arrow keys right/left	Display the next or previous channels

	Button, input/display field	Function
5	Delete	Delete values
6	Exit	Changes to the higher menu

8.4.3 Lot size

Access to three counters is opened via the **Lot size** button:

- Job counter: Number of OK parts and the total number of parts for a running job.
- Shift counter: Number of OK parts and the total number of parts of a shift.
- Tool counter: Total number of parts that have been processed with the current tool set.

Job counter

In menu "Lot size \ Job counter" the respective counter readings for the current job are displayed.

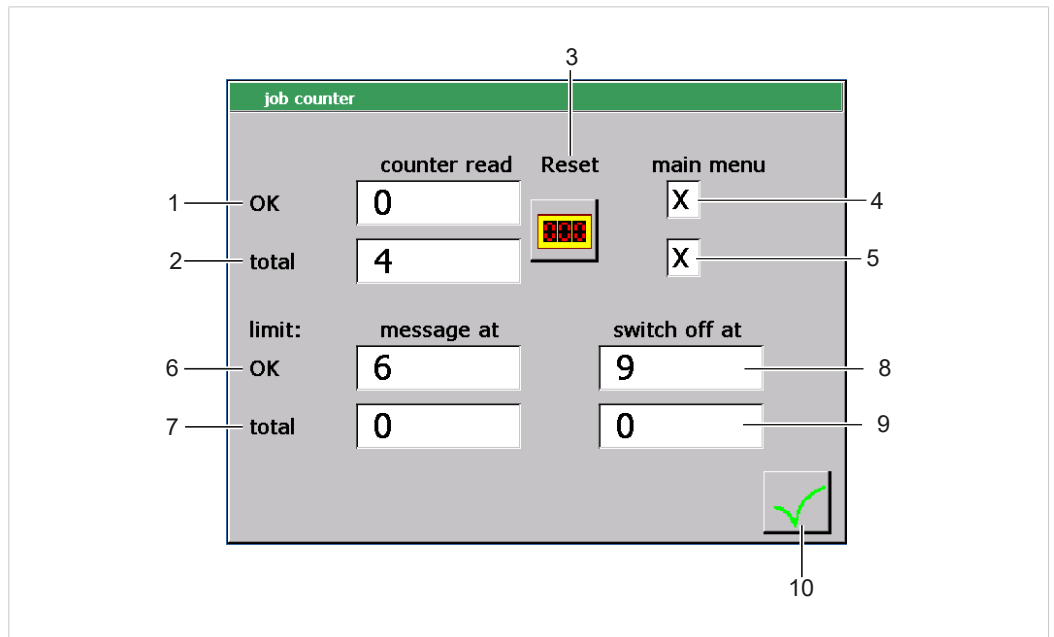

Fig. 24 Menu "Lot size \ Job counter"

	Field	Meaning
1	Counter value OK	Number of OK parts of the running job
2	Total counter value	Total number of parts of the running job
3	Reset	Resetting the counter Counter reading OK and Total counter reading
4	Main menu OK	The counter reading is displayed in the main menu when the checkbox is activated.

	Field	Meaning
5	Main menu total	The counter reading is displayed in the main menu when the checkbox is activated.
6	Message at OK	The number of the OK parts reached at which a stored yellow message is issued on the display. Value 0 deactivates the function.
7	Message at total	The number of the total parts reached at which a stored yellow message is issued on the display. Value 0 deactivates the function.
8	Switch-off at OK	The number of the OK parts reached at which the working process is ended and a stored red message is issued on the display.
9	Switch-off at total	The number of the total parts reached at which the working process is ended and a stored red message is issued on the display.
10	Accept	The settings are applied. The window will close.

Job counter - Switch-off at OK

A limit value can be entered in the input field **Switch-off at OK**. Once the counter value reaches the value, the 'Ready' signal is switched off and an error message is issued.

Tapping on the **Reset** button resets the counter. After that, the next measurement can be continued.

The value **0** deactivates the corresponding option. The system is not shut down and no message is issued.

- ✓ The user is logged in with a suitable user level. The necessary write permissions are available.
- ✓ Menu "Lot size \ Job counter" is open

1. Tap on the **Switch-off at OK** input field.
 - ▷ The numerical keyboard opens.
2. Enter the desired value and confirm with ↵.
Value **0** deactivates the function.

Reset "Switch-off at OK" counter

1. When the limit value in input field "Switch-off at OK" has been reached:
2. Reset the counter by tapping on the **Reset** button.
3. Start process again.

Job counter - Switch-off at total

A limit value can be entered in the input field **Switch-off at total**. As soon as the counter value reaches the value, a warning message is issued.

The value **0** deactivates the corresponding option. The system is not shut down and no message is issued.

- ✓ The user is logged in with a suitable user level. The necessary write permissions are available.
 - ✓ Menu "Lot size \ Job counter" is open
1. Tap on the **Switch-off at total** input field.
 - ▷ The numerical keyboard opens.
 2. Enter the limit value and confirm with ↵.
Value **0** deactivates the function.

Reset "Switch-off at total" counter

1. When the limit value in input field "Switch-off at total" has been reached:
2. Reset the counter by tapping on the **Reset** button.
3. Start process again.

Shift counter

In menu "Lot size \ Shift counter" the respective counter readings for the current job are displayed.

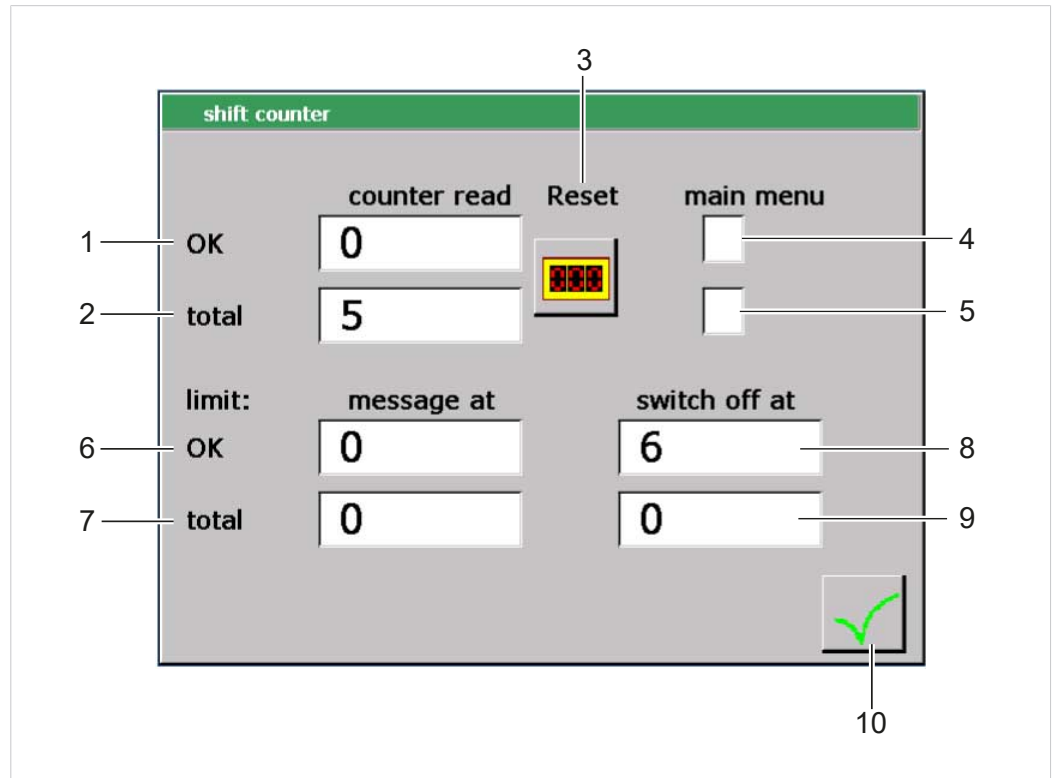

Fig. 25 Menu "Lot size \ Shift counter"

	Field	Meaning
1	Counter value OK	Number of OK parts of the current shift
2	Total counter value	Total number of parts of the current shift
3	Reset	Resetting the counter Counter reading OK and Total counter reading
4	Main menu OK	The counter reading is displayed in the main menu when the checkbox is activated.
5	Main menu total	The counter reading is displayed in the main menu when the checkbox is activated.
6	Message at OK	The number of the OK parts reached at which a stored yellow message is issued on the display. Value 0 deactivates the function.
7	Message at total	The number of the total parts reached at which a stored yellow message is issued on the display. Value 0 deactivates the function.
8	Switch-off at OK	The number of the OK parts reached at which the working process is ended and a stored red message is issued on the display.

	Field	Meaning
9	Switch-off at total	The number of the total parts reached at which the working process is ended and a stored red message is issued on the display.
10	Accept	The settings are applied. The window will close.

Shift counter - Switch-off at OK

A limit value can be entered in the input field **Switch-off at OK**. Once the counter value reaches the value, the working process shuts down and a corresponding message is issued.

Tapping on the **Reset** button resets the counter. After that, the next measurement can be continued.

The value **0** deactivates the corresponding option. The system is not shut down and no message is issued.

- ✓ The user is logged in with a suitable user level. The necessary write permissions are available.
- ✓ Menu "Lot size\Shift counter" is open

1. Tap on the **Switch-off at OK** input field.
 - ▷ The numerical keyboard opens.
2. Enter the desired value and confirm with ↵.
Value **0** deactivates the function.

Reset "Switch-off at OK" counter

1. When the limit value in input field "Switch-off at OK" has been reached:
2. Reset the counter by tapping on the **Reset** button.
3. Start process again.

Shift counter - Switch-off at total

A limit value can be entered in the input field **Switch-off at total**. Once the counter value reaches the value, the working process shuts down and a corresponding message is issued.

The value **0** deactivates the corresponding option. The system is not shut down and no message is issued.

- ✓ The user is logged in with a suitable user level. The necessary write permissions are available.
 - ✓ Menu "Lot size\Shift counter" is open
1. Tap on the **Switch-off at total** input field.
 - ▷ The numerical keyboard opens.
 2. Enter the limit value and confirm with ↵.
Value **0** deactivates the function.

Reset "Switch-off at total" counter

1. When the limit value in input field "Switch-off at total" has been reached:
2. Reset the counter by tapping on the **Reset** button.
3. Start process again.

Tool counter

In menu "Lot size \ tool counter" the respective counter readings for the current job are displayed.

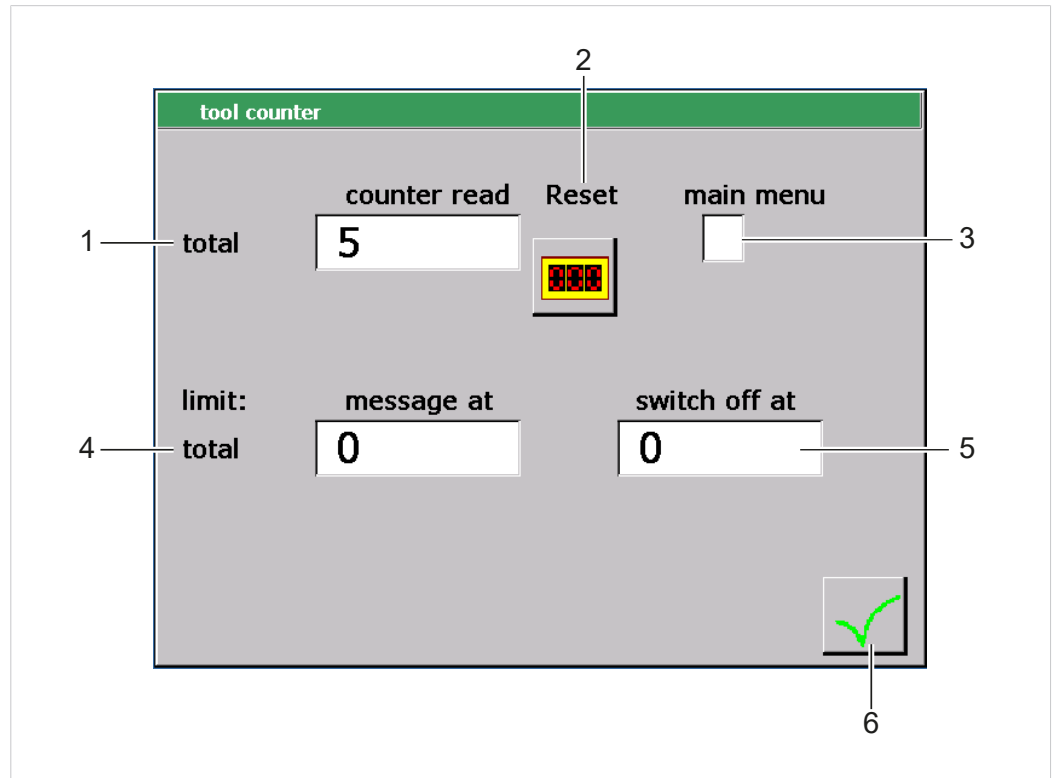

Fig. 26 Menu "Lot size \ Tool counter"

	Field	Meaning
1	Total counter value	Total number of parts (OK and NOK) that were produced with this tool.
2	Reset	Reset of counter Total counter reading
3	Main menu total	The counter reading is displayed in the main menu when the checkbox is activated.
4	Message at total	The number of the total parts reached at which a stored yellow message is issued on the display. Value 0 deactivates the function.
5	Switch-off at total	The number of the total parts reached at which the working process is ended and a stored red message is issued on the display.
6	Accept	The settings are applied. The window will close.

Tool counter - Switch-off at total

A limit value can be entered in the input field **Switch-off at total**. Once the counter value reaches the value, the working process shuts down and a corresponding message is issued.

The value **0** deactivates the corresponding option. The system is not shut down and no message is issued.

- ✓ The user is logged in with a suitable user level. The necessary write permissions are available.
 - ✓ Menu "Lot size\Tool counter" is open
1. Tap on the **Switch-off at total** input field.
 - ▷ The numerical keyboard opens.
 2. Enter the limit value and confirm with ↵.
Value **0** deactivates the function.

Reset "Switch-off at total" counter

1. When the limit value in input field "Switch-off at total" has been reached:
2. Reset the counter by tapping on the **Reset** button.
3. Start process again.

8.4.4 Supplement

The access is opened via the **Supplement** button:

- User administration: Administration of the access levels / the password
- Language: Change language
- Communication parameters: PC-interface (Field bus address)
- Inputs/outputs: Actual state of digital inputs/outputs
- Date/Time: Display of the current time / current date
- Device name: Entry of the device name.

User administration

In the "Supplement/User administration" the user can:

- Log in with a specific user level.
- Log out from the active user level.
- Change the password

Log user in and out

The process monitoring system has an authorization management system that can limit or enable different operating options and configuration options.

Authorization	Description	Password
Level 0	Machine operator Functions for observing the measurement data and program selection are enabled.	No password required
Level 1	Installers and experienced machine operators: Changes of values within the program are enabled.	TOX
Level 2	Authorized installer and system programmer: Also configuration data can be changed.	TOX2
Level 3	Plant construction and maintenance: Also extended additional configuration data can be changed.	TOX3

Log in user

- ✓ Menu "Supplement\User administration" is open.
- 1. Tap on the **Login** button.
 - ▷ The alphanumeric keyboard opens.
- 2. Enter the password of the authorization level and confirm with ↵.
 - ▶ If the password was entered correctly, the selected authorization level is active.
 - OR -
 - If the password was entered incorrectly, a message will appear and the login procedure will be canceled.
 - ▶ The actual authorization level is displayed at the top of the screen.

Log out user

- ✓ Menu "Supplement\User administration" is open.
- ✓ The user is logged in with level 1 or higher.
- ➔ Tap on the **Logout** button.
 - ▶ The authorization level changes to the next lower level.
 - ▶ The actual authorization level is displayed at the top of the screen.

Change password

The password can only be changed for the authorization level in which the user is currently logged in. the user is logged in.

- ✓ Menu "Supplement\User administration" is open

- 1. Tap the **Change password** button.
 - ▷ A dialog window opens with the request to enter the current password.
 - ▷ The alphanumeric keyboard opens.
- 2. Enter the current password and confirm with ↵.
 - ▷ A dialog window opens with the request to enter the new password.
 - ▷ The alphanumeric keyboard opens.
- 3. Enter the new password and confirm with ↵.
 - ▷ A dialog window opens with the request to enter the new password again.
 - ▷ The alphanumeric keyboard opens.
- 4. Enter the new password again and confirm it with ↵.

Changing Language

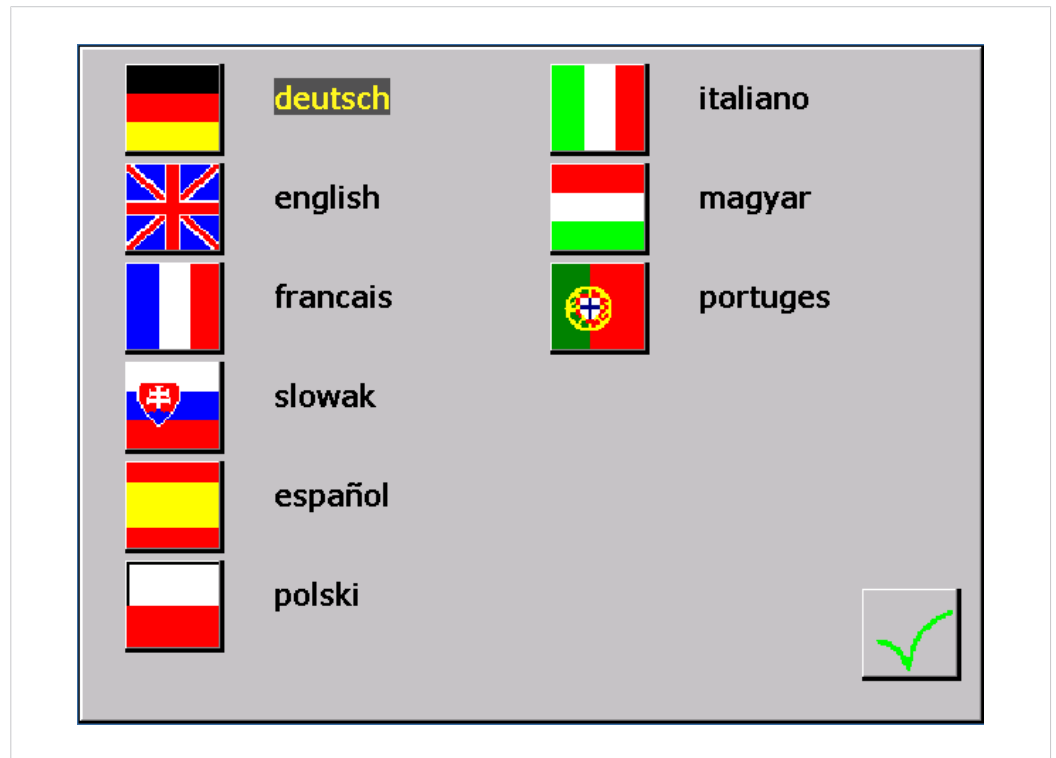

Fig. 27 Menu "Supplement / Language"

In the "Supplement \ Language" menu, you have the option to change the user interface language.

- ✓ The user is logged in with a suitable user level. The necessary write permissions are available.
- ➔ Tap on the desired language to select it.
- ▶ The selected language will be available immediately

Configure communication parameters

In the "Supplement / Communication parameters" menu the user can:

- Change the IP address
- Change the field bus parameters
- Enable the remote access

Change the IP address

In menu "Supplement \ Configuration parameter\IP address" the Ethernet IP address, the subnet mask and the default gateway can be changed.

Defining IP address via the DHCP protocol

✓ The user is logged in with a suitable user level. The necessary write permissions are available.

1. Tap on **DHCP** checkbox.
2. Tap the **Accept** button.
3. Restart the device.

Defining IP Address by entering a Value

✓ The user is logged in with a suitable user level. The necessary write permissions are available.

1. Tap on the first input field of the **IP address** group, enter the first three digits of the IP address to be used and press the **OK** button to confirm.
 - ▷ The numerical keyboard opens.
2. Repeat the procedure for all input fields in the **IP address** group.
3. Repeat point 2 and 3 to enter the **Subnet mask** and **Default Gateway**.
4. Tap the **Accept** button.
5. Restart the device.

Field bus parameters

Depending in the type of field bus (e.g. Profinet, DeviceNet, etc.) this picture can deviate slightly and be supplemented by specific field bus parameters.

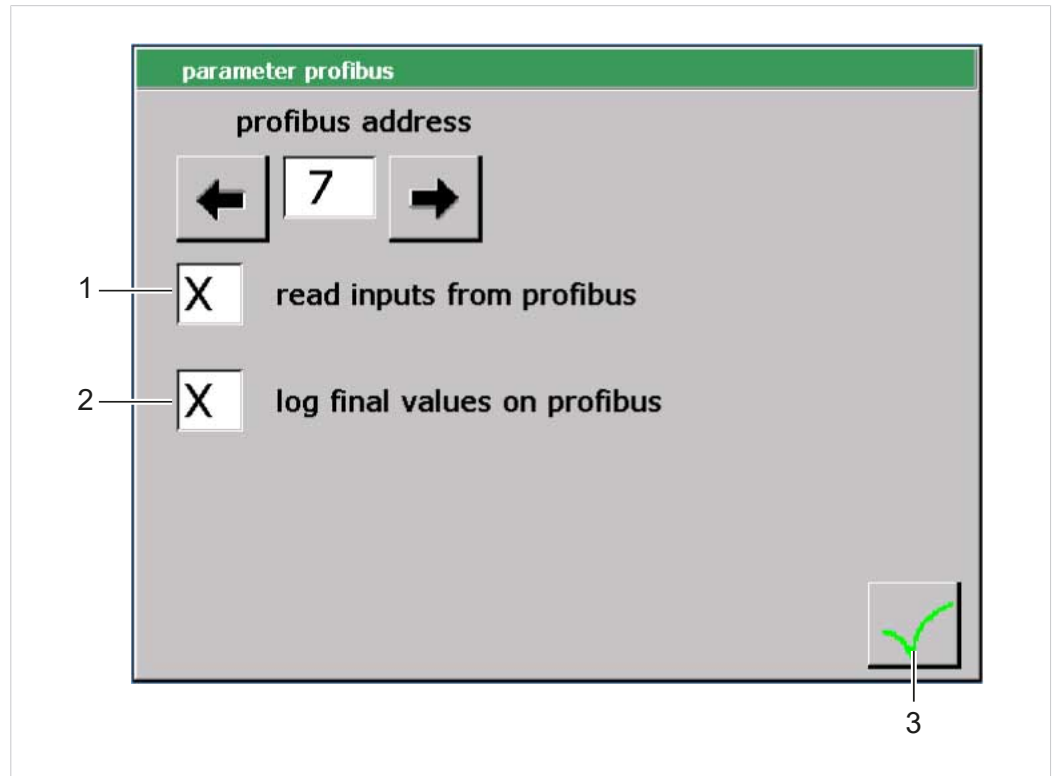

	Button, input/control panel	Function
1	Read inputs to Profibus	Activate or deactivate the selected function.
2	Log final values on Profibus	Activate or deactivate the selected function.
3	Accept	Closes the window. The displayed parameters will be adopted.

Selection by entering a Value

- ✓ The user is logged in with a suitable user level. The necessary write permissions are available.
1. Tap on the **Profibus address** input field.
 - ▷ The numerical keyboard opens.
 2. Enter the Profibus address and confirm with the ↵ button.
 3. Restart the device.

Selection by Function Buttons

- ✓ The user is logged in with a suitable user level. The necessary write permissions are available.
1. Select the Profibus address by tapping the ⇒ or ⇐ buttons.
 2. Restart the device.

Enable the remote access

The remote access for TOX® PRESSOTECHNIK can be enabled in menu "Supplement \ Configuration parameters\Remote access".

- ✓ The user is logged in with a suitable user level. The necessary write permissions are available.
 - ✓ Menu "Supplement -> Configuration parameters\Remote access" is open.
- ➔ Tap on the **Remote access** button.
- ▷ Remote access is enabled.

In-/Outputs

In the "Supplement -> In-/Outputs" menu the user can:

- Check the current status of the internal digital inputs and outputs.
- Check the current status of the field bus inputs and outputs.

Checking the internal In-/Outputs

In menu "Supplement -> In-/Outputs | Internal I/O" the current status of the internal digital inputs and outputs can be checked.

Status:

- Active: The corresponding input or output is marked with a green square.
- Not active: The corresponding input or output is marked with a red square.

The function of an input or output is described in plain text.

Activating or deactivating output

- ✓ The user is logged in with a suitable user level. The necessary write permissions are available.
- ✓ Menu "Supplement -> In-Outputs | Internal digital I/O" is opened.
- ➔ Tap on the button below the desired input or output.
- ▶ The field changes from red to green or green to red.
- ▶ The input or output is activated or deactivated.
- ▶ The change becomes effective immediately.
- ▶ The change remains effective until the "Inputs/outputs" menu is exited.

Change byte

- ✓ The user is logged in with a suitable user level. The necessary write permissions are available.
- ✓ Menu "Supplement -> In-Outputs | Internal digital I/O" is opened.
- ➔ Tap the cursor button at the top edge of the screen.
- ▶ The byte changes from "0" to "1" or reverse.

BYTE	Bit
0	0 - 7
1	8 - 15

Check field bus In-/Outputs

In menu "Supplement -> In-/Outputs | Field bus I/O" the current status of the field bus inputs and outputs can be checked.

Status:

- Active: The corresponding input or output is marked with a green square.
- Not active: The corresponding input or output is marked with a red square.

The function of an input or output is described in plain text.

Activating or deactivating output

- ✓ The user is logged in with a suitable user level. The necessary write permissions are available.
- ✓ Menu "Supplement -> In-Outputs | Field bus I/O" is opened.
- ➔ Tap on the button below the desired input or output.
- ▶ The field changes from red to green or green to red.
- ▶ The input or output is activated or deactivated.
- ▶ The change becomes effective immediately.
- ▶ The change remains effective until the "Field bus" menu is exited.

Change byte

- ✓ The user is logged in with a suitable user level. The necessary write permissions are available.
- ✓ Menu "Supplement -> In-Outputs | Field bus I/O" is opened.
- ➔ Tap the cursor button at the top edge of the screen.
- ▶ The byte changes from "0" to "15" or reverse.

BYTE	Bit		BYTE	Bit
0	0 - 7		8	64 - 71
1	8 - 15		9	72 - 79
2	16 - 23		10	80 - 87
3	24 - 31		11	88 - 95
4	32 - 39		12	96 - 103
5	40 - 47		13	104 - 111
6	48 - 55		14	112 - 119
7	56 - 63		15	120 - 127

Setting Date/Time

In the "Supplement -> Date/Time" menu, the device time and device date can be configured.

- ✓ The user is logged in with a suitable user level. The necessary write permissions are available.
 - ✓ The "Supplement -> Date/Time" menu is opened.
1. Tap on the **Time** or the **Date** input fields.
 - ▷ The numerical keyboard opens.
 2. Enter the values in the corresponding fields and confirm with ↵.

Change device name

The device name is used, for example, to create a folder with the device name on the data medium during the creation of a backup on a USB stick. This makes it clear in case of several process monitoring systems, on which device this backup was created.

- ✓ The user is logged in with a suitable user level. The necessary write permissions are available.
 - ✓ The "Menu Supplement | Device name" is opened.
1. Tap on **Device name** input field.
 - ▷ The alphanumeric keyboard opens.
 2. Enter the device name and confirm with ↵.

8.4.5 Valuation options

If an acknowledgement type (acknowledgement external or per display) was selected, a NOK measurement must be acknowledged before the pressing monitor is ready to measure again.

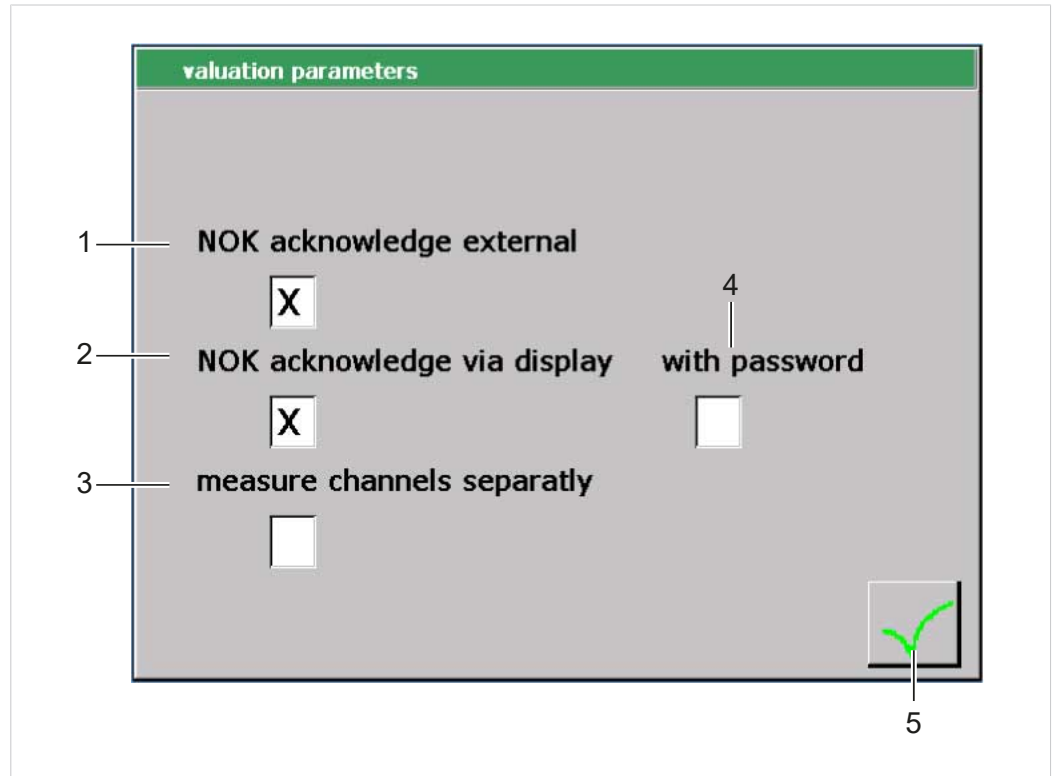

Fig. 28 "Configuration \ NIO options" menu

	Button	Function
1	External NOK acknowledgement	The NOK message must always be acknowledged via an external signal.
2	NOK acknowledgement per display	The NOK message must be acknowledged via the display.
3	Separate measurement of channels	The measurement for channel 1 and channel 2 can be started, ended and evaluated separately. Only available with a process monitoring system with 2 channels.
4	With password	The NOK message can only be acknowledged via the display after the entry of the password.

Activate external NOK acknowledgement

- ✓ The user is logged in with a suitable user level. The necessary write permissions are available.
- 1. Tap on **external NOK acknowledgement** checkbox to activate external acknowledgement.
- 2. Tap on the **Accept** button to save the values.

Activating NOK acknowledgement per display

- ✓ The user is logged in with a suitable user level. The necessary write permissions are available.
- 1. Tap on **NOK acknowledgement per display** checkbox to activate the acknowledgement per display.
- 2. Tap on the checkbox **With password** to enter the password of authorization level 1, the one who can perform the acknowledgment.
- 3. Tap on the **Accept** button to save the values.

Separate measurement of channels

In case of a 2-channel device, the measurement for channel 1 and channel 2 can each be started, ended and evaluated separately.

- ✓ The user is logged in with a suitable user level. The necessary write permissions are available.
- ✓ The device is 2-channel capable.
- 1. Tap on **external NOK acknowledgement** checkbox to activate external acknowledgement.
- 2. Tap on the **Measure channels separately** button to display the status of the measurement carried out last.

8.4.6 Messages

The information and status bar displays messages as soon as a warning or error occurs:

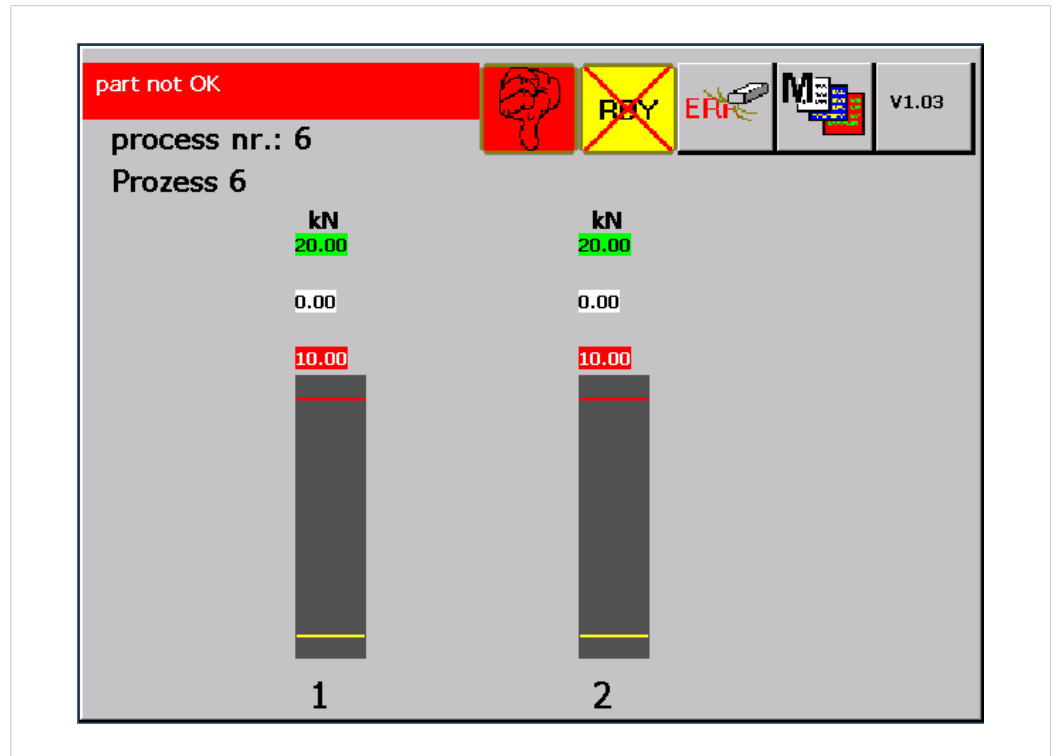

- Yellow background: Warning message
- Red background: Error message:

The following messages are displayed in the measurement menu:

- OK job counter limit reached
- Total job counter limit reached
- OK shift counter limit reached
- Total shift counter limit reached
- Tool counter limit reached
- Offset limit force sensor exceeded
- piece part NOK

9 Troubleshooting

9.1 Detecting faults

Faults are displayed as alarms. Depending on the type of fault, the alarms are displayed as errors or warnings.

Alarm Type	Display	Meaning
Warning	Text with a yellow background in the measurement menu of the device.	--
Fault	Text with a red background in the measurement menu of the device.	The next measurement is disabled and must be eliminated and acknowledged.

9.1.1 Acknowledging Messages

After a fault, the button **Error reset** appears in the main screen.

- Tap on the **Error reset** button.
- ▶ The fault is reset.

9.1.2 Analyzing NOK situations

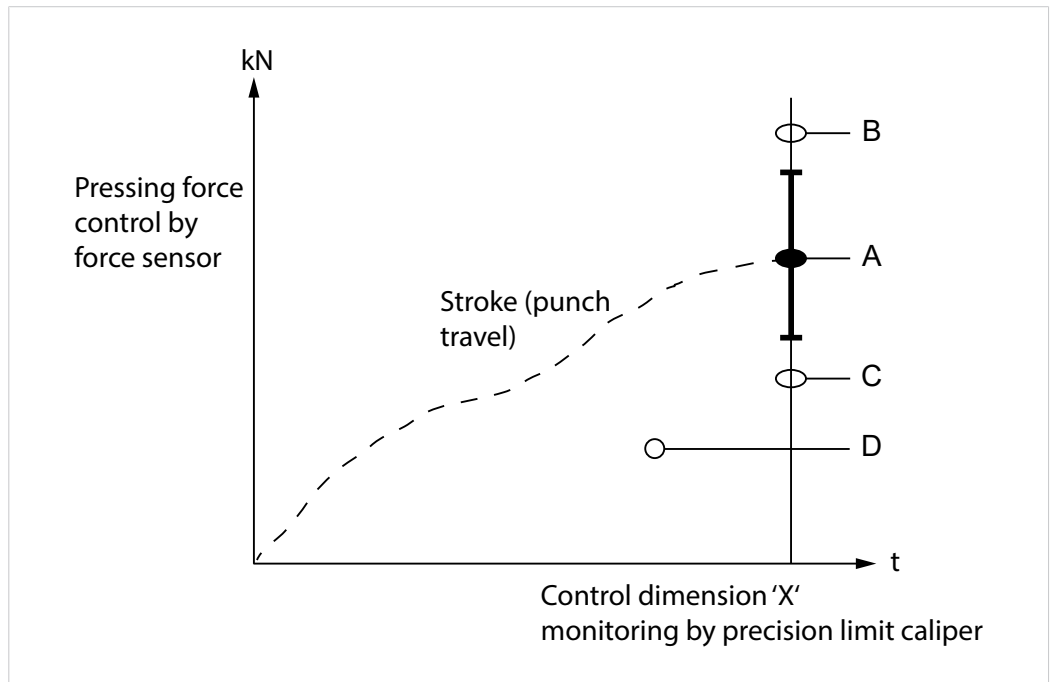

Error source	Meaning
a	Measuring point OK (measuring point is within the window)
B	Press force too high (Display: Error code <MAX>)
C	Press force too low (Display: Error code <MIN>)
D	No measurement (No change to display; 'ready to measure' signal remains present, no edge transition)

Tab. 19 Error sources

9.1.3 Error messages

Fault	Cause	Analysis	Measure
Press force too high Display error code <MAX>)	Sheets too thick	Generally affects all points	Measure sheet thicknesses and compare with tool passport.
		Error following batch change	Use specified sheet thicknesses.
		Tolerance when increasing individual sheet thickness > 0.2 - 0.3 mm	If the sheet thicknesses are within the permissible tolerances, draw up a batch-based testing plan.
	Sheet strength increased	Generally affects all points	Compare material designations for the sheets with TOX®- tool passport.
		Error following batch change	If necessary: Perform a hardness comparison measurement.
			Use specified materials. Draw up a hardness-based testing plan.
	Number of sheet layers too high	Generally affects all points	Compare number of sheet layers with the specifications in the TOX®- tool passport.
		One-off occurrence as a result of incorrect operation	Repeat joining process with the correct number of sheet layers.
	Deposits in the die	Only affects individual points	Clean affected dies.
		Oil, dirt, remains of paint, etc. in the ring channel of the die	If the problem continues, dismantle and clean the die; polishing or chemical etching may be carried out following discussions with TOX® PRES-SOTECHNIK.
	Sheet surface is very dry, rather than being lightly oiled or greased	Check the state of the sheet surface	Ensure sheet surfaces are oiled or greased.
		Change to the working process (e.g. unplanned washing step prior to joining)	If necessary: Draw up a special testing program for dry sheet surface. Warning: Check stripping force on the punch side.
	Sheets / piece parts not correctly positioned	Damage caused to piece parts by tool or stripper	Repeat joining process with the piece parts correctly positioned.
			If necessary: Improve fixing means for the piece part.
	Incorrect tool combination installed	Control dimension 'X' too small after tool change	Compare tool designation (imprinted on the shaft diameter) with the specifications in the TOX®- tool passport.
		Die press-through depth too small	
Point diameter too small			
Punch diameter too large (> 0.2 mm)			

Fault	Cause	Analysis	Measure
Press force too small Display error code <MIN>	Sheets too thin	Generally affects all points	Measure sheet thicknesses and compare with TOX®- tool passport.
		Error following batch change	Use specified sheet thicknesses.
		Tolerance when reducing individual sheet thickness > 0.2 – 0.3 mm	If the sheet thicknesses are within the permissible tolerances, draw up a batch-based testing plan.
	Sheet strength reduced	Generally affects several points	Compare material designations for the sheets with TOX®- tool passport.
		Error following batch change	If necessary: Perform a hardness comparison measurement.
			Use specified materials. Draw up a hardness-based testing plan.
	Sheet parts missing or only one sheet layer present	Affects all points	Repeat joining process with the correct number of sheet layers.
		One-off occurrence as a result of incorrect operation	
	Sheet surface is oiled or greased rather than being very dry	Check the state of the sheet surface	Carry out a washing step prior to joining.
		Change to the working process (e.g. washing step prior to joining omitted)	If necessary: Draw up a special testing program for greased / oiled sheet surface.
	Broken punch	Joining point hardly present or not at all	Replace faulty punch.
	Broken die	Joining point is no longer round in shape	Replace faulty die.
	Incorrect tool combination installed	Following tool change	Compare tool designation (imprinted on the shaft diameter) with the specifications in the TOX®- tool passport.
		Control dimension 'X' too large	
Die press-through depth too large			
Cylindrical duct through the die too large			
Point diameter too large			
After switching on or zero-point check, error code 'Offset adjustment' appears (no valid zero-point value)	Broken cable at force transducer	Following tool change	Replace faulty force transducer.
		After removal of tool unit	
	Measuring element in the force transducer is faulty	The force transducer can no longer be calibrated	
		Zero point is unstable	
		The force transducer can no longer be calibrated	

Fault	Cause	Analysis	Measure
Number of pieces reached Error 'Counter value reached'	Tool lifetime has been reached	Status signal Number of pieces reached is set	Check tool for wear and replace if necessary; re-set the lifetime counter.
Warning limit in succession Error 'Warning limit exceeded'	The preset warning limit has been exceeded n times	Status signal Warning limit in succession is set	Check tool for wear and replace if necessary; re-set the counter by quitting the measurement menu.

9.2 Battery buffer

This data is stored on the battery buffered SRAM and may be lost in case of an empty battery:

- Set language
- Currently selected process
- Counter values
- End value data and sequential number of end values

10 Maintenance

10.1 Maintenance and repair

The recommended time intervals for inspection work and maintenance work must be observed.

The correct and proper repair of the TOX® PRESSOTECHNIK product can only be assured by appropriately trained specialists. The operating company or the personnel in charge of the repair must ensure that the repair personnel are properly trained in the repair of the product.

The repairers themselves are always responsible for the work safety.

10.2 Safety during maintenance

The following applies:

- Observe maintenance intervals if present and stipulated.
- Maintenance intervals may vary from the stipulated maintenance intervals. The maintenance intervals may have to be verified with the manufacturer if necessary.
- Perform only maintenance work that is described in this manual.
- Inform operating personnel before starting repair work.
- Appoint a supervisor.

10.3 Change flash card

The flash card is located on the back of the inside (display), the housing may have to be dismantled.

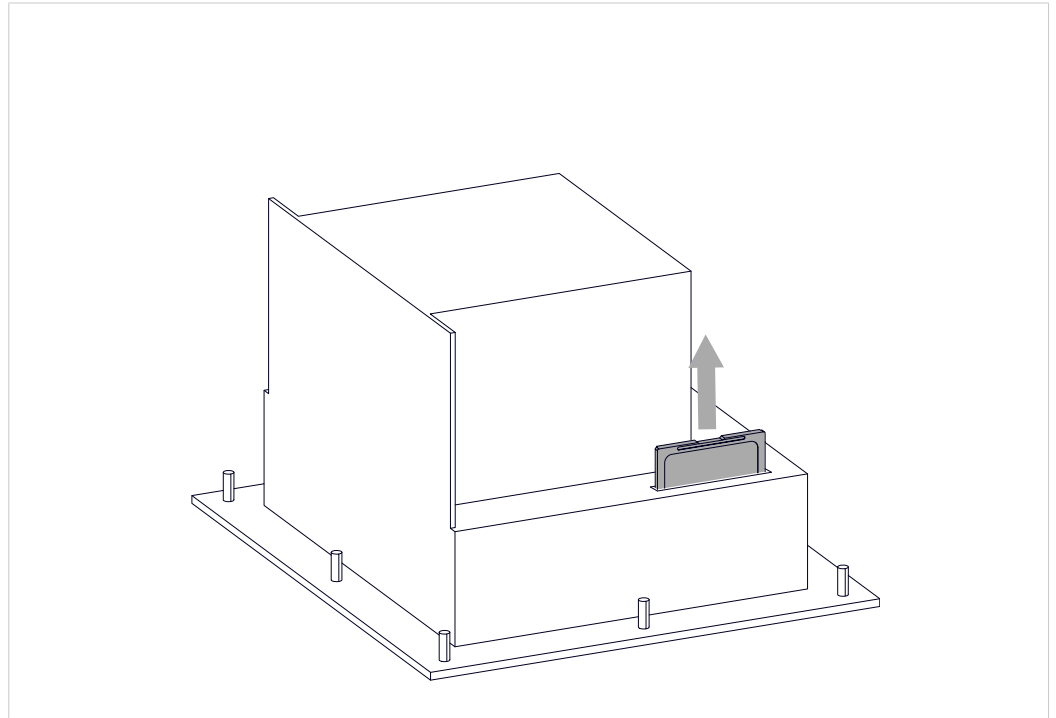



Fig. 29 Change flash card

- ✓ Device is de-energized.
- ✓ Person is electrostatically discharged.

1. Loosen screw and turn safety device to the side.
2. Remove the flash card upwards.
3. Insert new flash card.
4. Slide safety device back over flash card and tighten screw.

10.4 Battery change

 TOX® PRESSOTECHNIK recommends a battery change after 2 years at the latest.

- ✓ Device is de-energized.
- ✓ Person is electrostatically discharged.
- ✓ Electrically **non** conductive tool for removing the battery.

1. Remove the cover of the lithium battery
2. Pull the battery out with an insulated tool
3. Install new lithium battery in the correct polarity.
4. Install the cover.

Maintenance table

The specified intervals are only approximate values. Depending on the area of application, the actual values may differ from the guide values.

Maintenance cycle	Additional information	
2 years	10.4	Battery change

11 Repairs

11.1 Repair work

No repair work is necessary.

12 Disassembly and Disposal

12.1 Safety requirements for disassembly

→ Have the disassembly carried out by qualified personnel.

12.2 Disassembly

1. Shut down system or component.
2. Disconnect system or component from the supply voltage.
3. Remove all connected sensors, actuators or components.
4. Disassemble system or component.

12.3 Disposal



When disposing of packaging, consumables and spare parts, including the machine and its accessories, the relevant national environmental protection regulations must be complied with.



For the environmentally compatible utilization and disposal of its electronic components, please contact the certified disposal company for electronic waste or return it to TOX® PRESSOTECHNIK.

For further information about the take-back and forms see www.tox.com in the service sector.

Regarding questions about disposal please contact TOX® PRESSOTECHNIK GmbH & Co. KG (see [Contact and source of supply, Page 10](#)).

13 Appendices

13.1 Declaration of conformity

EU DECLARATION OF CONFORMITY

Original EU declaration of conformity

TOX® PRESSOTECHNIK GMBH & CO. KG herewith declares that the concept and design of the monitoring system hereinafter and the execution traded by us

Designation/function terminal for process monitoring
Product name/module EPW /CEP
Model/type 400.xxx / 400T.xx
Serial number See type plate

complies with the relevant EU Directives and Applied harmonized standard:

2011/65/EU:2011 RoHS-Directive
2014/30/EU:2014 EMC Directive

Applied harmonized standards:

DIN EN 61000-6-2 :2006 Electromagnetic compatibility (EMC) - Part 6-2: Generic standards - Immunity for industrial environments
DIN EN 61000-6-4 :2011 Electromagnetic compatibility (EMC) - Part 6-4: Generic standards - Immunity for industrial environments
DIN EN 50581:2012 Technical documentation for the assessment of electrical and electronic equipment with regard to the restriction of hazardous substance

Place, date Weingarten, 30.01.2020
Manufacturer TOX® PRESSOTECHNIK GMBH & CO. KG

Signature



Information on the signatory: ppa. Stefan Katzenmaier

This declaration certifies the conformity with the essential requirements of the indicated directive(s), it does not, however, covenant any characteristics. The instructions for safety and installation of the enclosed product documentation have to be observed.

13.2 UL certificate



NOTICE OF COMPLETION AND INITIAL PRODUCTION INSPECTION

2019-08-30

TOX-PRESSOTECHNIK L L C
MR. ERIC SEIFERTH
4250 Weaver Pkwy
Warrenville, IL, 60555-3924 USA

Our Reference: File E503298, Vol. D1 Project Number: 4788525144
Your Reference: Models EPW 400, Smart9 T070E, Smart9 T057, STE 341-xxx T070, STE346-0005, CEP 400T, Touch Screen PLC's
Project Scope: UL Listing to the following standard(s):
UL 61010-1, 3rd Edition, May 11, 2012, Revised April 29 2016, CAN/CSA-C22.2 No. 61010-1-12, 3rd Edition, Revision dated April 29 2016
Subject: Notice of Project Completion with Initial Production Inspection

Dear MR. ERIC SEIFERTH:

Congratulations! UL's investigation of your product(s) has been completed under the above Reference Numbers and the product was determined to comply with the applicable requirements. The Test Report and records in the Follow-Up Services Procedure covering the product are completed and are now being prepared (if you do not have a separate CB Report, you can to access the Test Report now). **Please have the appropriate person in your company that is responsible for receiving/managing UL reports access an electronic copy of the Test Report and FUS Procedure through the CDA feature on MyHome@UL, or if you desire another method of receiving the report please contact one of the contacts below. If you are not familiar with our MyHome site or need to create a new account in order to access your reports, please click the link [HERE](#).**

PLEASE NOTE: YOU ARE NOT AUTHORIZED TO SHIP ANY PRODUCTS BEARING ANY UL MARKS UNTIL THE INITIAL PRODUCTION INSPECTION HAS BEEN SUCCESSFULLY CONDUCTED BY THE UL FIELD REPRESENTATIVE.

An Initial Production Inspection (IPI) is an inspection that must be conducted prior to the first shipment of products bearing the UL Mark. This is to ensure that products being manufactured are in accordance with UL LLC's requirements including the Follow-Up Service Procedure. After the UL Representative has verified compliance of your product(s) at the manufacturing locations listed below, authorization will be granted for shipment of product(s) bearing the appropriate UL Marks as denoted in the Procedure (located in the FUS Documentation of the report).

List of all manufacturing locations (please contact us if any are missing):

Manufacturing Facility(ies): TOX PRESSOTECHNIK GMBH & CO. KG
Riedstraße 4
88250 Weingarten Germany
Contact Name: Eric Seifertth
Contact Phone No.: 1 630 447-4615
Contact Email: ESEIFERTH@TOX-US.COM

It is the responsibility of TOX-PRESSOTECHNIK L L C, the Applicant, to inform its manufacturers of that the IPI must be successfully completed before product may be shipped with the UL Mark. Instructions for the IPI will be sent to our inspection center nearest to each of your manufacturing locations. The contact information of the inspection center is provided above. Please contact the inspection center to schedule the IPI and ask any questions you may have regarding the IPI.

Inspections at your production facility will be conducted under the supervision of:

Area Manager:	ROB GEUIJEN
IC Name:	UL INSPECTION CENTER GERMANY,
Address:	UL INTERNATIONAL GERMANY GMBH ADMIRAL-ROSENDAHL-STRASSE 9, NEU-ISENBURG, Germany, 63263
Contact Phone:	69-489810-0

Email:

Marks (as needed) may be obtained from:

Information on the UL Marks, including our new Enhanced UL Certification Marks can be found on the UL website at <https://markshub.ul.com>

Within Canada, there are federal and local statutes and regulations, such as the Consumer Packaging and Labeling Act, requiring the use of bilingual product markings on products intended for the Canadian market. It is the responsibility of the manufacturer (or distributor) to comply with this law. The UL Follow-Up Service Procedures will only include the English versions of the markings

Any information and documentation provided to you involving UL Mark services are provided on behalf of UL LLC (UL) or any authorized licensee of UL.

Feel free to contact me or any of our Customer Service representatives if you have any questions.

UL is strongly committed to providing you with the finest customer experience possible. You may receive an email from ULsurvey@feedback.ul.com inviting you to please participate in a brief satisfaction survey. Please check your spam or junk folder to ensure receipt of the email. The subject line of the email is "Tell us about your recent experience with UL." Please direct any questions about the survey to ULsurvey@feedback.ul.com. Thank you in advance for your participation.

Very truly yours,

Brett VanDoren
847-664-3931
Staff Engineer
Brett.c.vandoren@ul.com

Index

Symbols

Menu	
Supplement.....	79

A

Adjustment	
Force sensor.....	65
Analyzing	
NOK situations.....	93

B

Basic safety requirements.....	11
Battery change.....	99
Buttons	
Function buttons.....	51

C

Calibration	
Force sensor.....	67
Change	
Device name.....	88
Password.....	81
Change flash card.....	98
channel	
Naming the.....	61
Checkboxes.....	51
Commissioning.....	48
Communication parameters	
Configure.....	82
configuration	
Apply.....	70
Force sensor.....	62
Naming the channel.....	61
Nominal force of force sensor.....	65
Configure	
Communication parameters.....	82
Connections.....	24
Contact.....	10
Control elements.....	51
Counter	
Switch-off at OK.....	73, 76
Switch-off at total.....	74, 77, 79

D

Date	
Set.....	88
Declaration of conformity.....	103
description	
Function.....	16
Device name	
Change.....	88
Dialog	
Keyboard.....	52
Digital inputs.....	24
Digital outputs.....	27, 28, 30, 31, 32, 33
Dimensions.....	20
Hole pattern of installation housing.....	21
Installation housing.....	20
Wall/table housing.....	22
Disassembly.....	102
Safety.....	102
Dispatch	
Repair.....	47
Disposal.....	102
DMS signals.....	36
Document	
additional.....	7
Validity.....	7

E

Electromagnetic compatibility.....	34
Enable	
Remote access.....	85
Environmental conditions.....	34
Error message.....	94
Ethernet	
Networking.....	18
Transfer of measuring data.....	18
Exclusion of liability.....	6

F

Faults
 Battery buffer 96
 Detect 92
 Field bus parameters
 Change 84
 Force measurement 16
 Force monitoring 16
 Force sensor
 Adjust offset 65
 Calibration 67
 Configuring the 62
 Forced offset 66
 Setting the filter 67
 Setting the nominal force of the 65
 Setting the offset limit 66
 Forced offset
 Force sensor 66
 Function
 Software 50
 Function buttons 51
 Function description 16
 Force measurement 16
 Force monitoring 16
 Test of the final position 17

G

Gender note 7

H

Hardware configuration 23
 Hazard
 Electrical 13
 Hazard potential 13

I

Icons 53
 Identification
 Product 15
 Images
 Highlighting 9
 Important information 6
 Information
 Important 6
 Input field 51
 Inputs 85
 Interface
 Software 50
 IP address
 Change 83

J

Job counter
 Switch-off at OK 73
 Job counter
 Switch-off at total 74

K

Keyboard 52

L

Language
 Change 82
 Legal note 6
 Liability 14
 limits
 Editing min/max 56
 Log CEP 200 18
 Log in 80
 Log out 80
 Lowercase
 permanent 53

M

- Main menus 55
- Maintenance 97
 - Safety 97
- Measurement menu 91
- Measures
 - Organizational 11
- measuring cycles
 - Setting 61
- Measuring sensor
 - Supply voltage 35
- Mechanical specifications 19
- Menu
 - Communication parameters 82
 - Configuration 60
 - Copying the process 57, 58
 - Data 71
 - Date/Time 88
 - Device name 88
 - Field bus I/O 86
 - Field bus parameters 84
 - Force sensor 62
 - Force sensor calibration 67
 - Inputs/outputs 85
 - Internal digital I/O 85
 - IP address 83
 - Job counter 72
 - Language 82
 - Lot size 72
 - Measurement menu 91
 - Remote access 85
 - Shift counter 75
 - Tool counter 78
 - User administration 79
 - Valuation options 89
- Message
 - acknowledge 92
 - Error 94
- Messages 91
- Min/max limits 56
- Mode
 - Measuring 42, 43
- mode sequence
 - Measuring 42, 43
- Monitoring
 - Operation 49
 - Process 16

N

- name
 - Enter process 55
 - Process 55
- Network server program 18
- Networking
 - Ethernet 18
- Nominal load
 - Force sensor 65
- Note
 - Gender 7
 - General 9
 - Legal 6
 - Warning signs 8
- Numbers 53

O

- Offset adjustment 46
- Offset limit
 - Force sensor 66
- Operation 49
 - monitoring 49
- Organizational measures 11
- Outputs 85

P

- parameters
 - Restoring 59
 - Save 59
- Password
 - Change 81
- PLC interface
 - Offset adjustment 46
- Power supply 22
- Preparation
 - System 48
- Process
 - Assign name 56
 - select 55
- Process monitoring system 16
- processes
 - Min/max limits 56
- Product Identification 15
- Profibus interface 39, 40
- Pulse diagrams 42

Q

Qualifications 12

R

Remote access 85

 Enable 85

Repair

 Dispatch 47

Repairs 97, 101

S

Safety 11

 Maintenance 97

safety requirements

 Basic 11

 Operating company 11

Screw sensor with standard signal output 35

Select

 Process 55

Selection

 Personnel 12

Selection of personnel 12

Sensor

 Adjust offset 65

 Analog standard signals 35

Setting

 Date 88

 Force sensor filter 67

 Offset limit of force sensor 66

 Time 88

Setting the filter

 Force sensor 67

Shift counter

 Switch-off at OK 76

 Switch-off at total 77

Software 50

 Function 50

 Interface 50

Source of supply 10

Special characters 53

Starting

 System 48

Storage 47

 Temporary storages 47

Switch-off

 OK 73, 76

 Total 74, 77, 79

System

 preparing 48

 starting 48

T

Target group 7

Technical data 19

 Connections 24

 Digital inputs 24

 Digital outputs 27, 28, 30, 31, 32, 33

 Dimensions 20, 21, 22

 DMS signals 36

 Electromagnetic compatibility 34

 Environmental conditions 34

 Hardware configuration 23

 Mechanical specifications 19

 Power supply 22

 Profibus interface 39, 40

 Pulse diagrams 42

 Screw sensor with standard signal output 35

 Sensor 35

Test of the final position 17

 Clinching 17

Texts

 Highlighting 9

Time

 set 88

Tool counter

 Switch-off at total 79

Transfer of measuring data 18

Transport 47

Troubleshooting 92

Type plate 15

U

UL certificate 105

Uppercase

 permanent 53

User

 Log in 80

User administration 80

 Change password 81

User.

 Log out 80

V

Validity

 Document 7

Valuation options 89

W

warning limit

 Setting 61

Warning signs 8

Warranty 14